



APOIOS CILÍNDRICOS	2	DAF	36
GUARDA VENTO	3	FIAT	37
TUBO GASOLINA REFORÇO EXT.	4	FORD	59
TUBO GASOLINA REFORÇO INT.	4	FRUEHAUF	68
TUBO 3 TELAS ARTICULADO	4	HONDA	69
CORDÃO ESPONJOSO	4	HYUNDAI	70
TUBO ISOLAMENTO	4	INNOCENTI	71
TUBO CHAUFAGEM	4	ISUZU	73
TUBO RADIADOR A METRO	5	IVECO	76
TUBO TUBANO	5	LADA	79
TUBO RADIADOR CURVO 90°	5	LANCIA	80
FOLHA NATURAL PRETA SEM TELA	5	LAND ROVER	88
FOLHA NATURAL PRETA UMA TELA	5	MAN	89
FOLHA NATURAL PRETA DUAS TELAS	5	MAZDA	90
FOLHA NATURAL BRANCA DUAS TELAS	5	MERCEDES	96
FOLHA NEOPREN	5	MITSUBISHI	100
FOLHA NITRÍLICA	5	NISSAN	106
PLACA NATURAL	6	OPEL	120
PLACA NEOPREN	6	PEUGEOT	127
PLACA NITRÍLICA	6	POLSKY	141
PAVIMENTO CANELADO LARGO	6	RENAULT	142
PAVIMENTO CHECKER PRETO	6	ROR	165
PAVIMENTO ESTRIADO PRETO	6	ROVER	166
PAVIMENTO ESTRIADO CANE. PRETO	6	SCANIA	167
PAVIMENTO MOEDA PRETO	6	SEAT	169
PAVIMENTO PITONADO	6	SUBARU	179
FOLHA BORRACHA ANTI-ABRASIVA	7	SUZUKI	180
FOLHA BORRACHA CREPE	7	TALBOT-SIMCA	181
PALAS	8	TOYOTA	183
ALFA ROMEO	12	VOLKSWAGEN	196
AUDI	16	VOLVO	208
AUTOBIANCHI	19	DIVERSOS PESADOS	212
BMW	23		
BPW	25		
CITROËN	26		



15x10 MM4/5
15x15 MM4/5
15X20 MM4/5

20X10 MM6
20X15 MM6
20X20 MM6
20X25 MM6

25X10 MM6
25X15 MM6
25X20 MM6
25X25 MM6
25X30 MM6

30X15 MM8
30X20 MM8
30X25 MM8
30X30 MM8
30X35 MM8

40X15 MM8
40X20 MM8
40X25 MM8
40X30 MM8
40X35 MM8
40X40 MM8

50X20 MM10
50X25 MM10
50X30 MM10
50X35 MM10
50X40 MM10
50X45 MM10
50X50 MM10

60X20 MM10/12
60X25 MM10/12
60X30 MM10/12
60X35 MM10/12
60X40 MM10/12
60X45 MM10/12
60X50 MM10/12

70X20 MM10/12
70X25 MM10/12
70X30 MM10/12
70X35 MM10/12
70X40 MM10/12
70X45 MM10/12
70X50 MM10/12

75X20 MM10/12
75X25 MM10/12
75X30 MM10/12
75X35 MM10/12
75X40 MM10/12
75X45 MM10/12
75X50 MM10/12

100X40 MM14/16
100X45 MM14/16
100X50 MM14/16
100X55 MM14/16
100X60 MM14/16



15x15 MF4/5
15X20 MF4/5

20X15 MF6
20X20 MF6
20X25 MF6

25X15 MF6
25X20 MF6
25X25 MF6
25X30 MF6

30X15 MF8
30X20 MF8
30X25 MF8
30X30 MF8
30X35 MF8

40X15 MF8
40X20 MF8
40X25 MF8
40X30 MF8
40X35 MF8
40X40 MF8

50X25 MF10
50X30 MF10
50X35 MF10
50X40 MF10
50X45 MF10
50X50 MF10

60X20 MF10/12
60X25 MF10/12
60X30 MF10/12
60X35 MF10/12
60X40 MF10/12
60X45 MF10/12
60X50 MF10/12

70X25 MF10/12
70X30 MF10/12
70X35 MF10/12
70X40 MF10/12
70X45 MF10/12
70X50 MF10/12

75X20 MF10/12
75X25 MF10/12
75X30 MF10/12
75X35 MF10/12
75X40 MF10/12
75X45 MF10/12
75X50 MF10/12

100X40 MF14/16
100X45 MF14/16
100X50 MF14/16
100X55 MF14/16
100X60 MF14/16



15x10 PM4/5
15x15 PM4/5
15X20 PM4/5

20X10 PM6
20X15 PM6
20X20 PM6
20X25 PM6

25X10 PM6
25X15 PM6
25X20 PM6
25X25 PM6
25X30 PM6

30X15 PM8
30X20 PM8
30X25 PM8
30X30 PM8
30X35 PM8

40X15 PM8
40X20 PM8
40X25 PM8
40X30 PM8
40X35 PM8
40X40 PM8

50X15 PM10
50X20 PM10
50X25 PM10
50X30 PM10
50X35 PM10
50X40 PM10
50X45 PM10
50X50 PM10

60X20 PM10/12
60X25 PM10/12
60X30 PM10/12
60X35 PM10/12
60X40 PM10/12
60X45 PM10/12
60X50 PM10/12

70X20 PM10/12
70X25 PM10/12
70X30 PM10/12
70X35 PM10/12
70X40 PM10/12
70X45 PM10/12
70X50 PM10/12

75X20 PM10/12
75X25 PM10/12
75X30 PM10/12
75X35 PM10/12
75X40 PM10/12
75X45 PM10/12
75X50 PM10/12

100X40 PM14/16
100X45 PM14/16
100X50 PM14/16
100X55 PM14/16
100X60 PM14/16

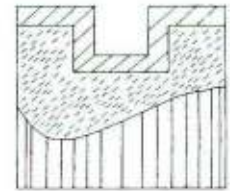

15x10 PF4/5
15x15 PF4/5
15X20 PF4/5

20X10 PF6
20X15 PF6
20X20 PF6
20X25 PF6

25X10 PF6
25X15 PF6
25X20 PF6
25X25 PF6
25X30 PF6

30X15 PF8
30X20 PF8
30X25 PF8
30X30 PF8
30X35 PF8

40X15 PF8
40X20 PF8
40X25 PF8
40X30 PF8
40X35 PF8
40X40 PF8

50X15 PF10
50X20 PF10
50X25 PF10
50X30 PF10
50X35 PF10
50X40 PF10
50X45 PF10
50X50 PF10

60X20 PF10/12
60X25 PF10/12
60X30 PF10/12
60X35 PF10/12
60X40 PF10/12
60X45 PF10/12
60X50 PF10/12

70X20 PF10/12
70X25 PF10/12
70X30 PF10/12
70X35 PF10/12
70X40 PF10/12
70X45 PF10/12
70X50 PF10/12

75X20 PF10/12
75X25 PF10/12
75X30 PF10/12
75X35 PF10/12
75X40 PF10/12
75X45 PF10/12
75X50 PF10/12

100X40 PF14/16
100X45 PF14/16
100X50 PF14/16
100X55 PF14/16
100X60 PF14/16



4598002	4598004	4598005
4598006	4598007	4598011
4598012	4598013	4598014
4598015	4598016	4598028
PVC	PVC	PVC
4598025	4598026	4598023



DÚVAL TEIXEIRA LOPES

PRODUTOS DE BORRACHA

TUBO GASOLINA COM REFORÇO EXTERIOR



REFERÊNCIA	Di	De
4595001	3	7
4595002	4	8
4595003	5	10
4595004	6	11
4595005	7	12
4595006	8	15
4595007	9	15
4595008	10	17
4595009	12	18
4595010	15	25

TUBO GASOLINA COM REFORÇO INTERIOR



REFERÊNCIA	Di	De
4597001	3.2	7
4597002	4	9
4597003	5	10
4597004	6	13
4597005	7.5	14.5
4597006	10	16
4597007	12	19

TUBO DE 3 TELAS ARTICULADO



REFERÊNCIA	Di
4591050	15
4591051	18
4591052	20
4591053	25
4591054	28
4591055	30
4591056	32
4591057	35
4591058	38
4591059	40
4591060	42
4591061	45
4561062	50
4597063	55
4591064	60
4591065	65

CORDÃO ESPONJOSO



REFERÊNCIA	De
4593001	2
4593002	3
4593003	4
4593004	5
4593005	6
4593006	7
4593007	8
4593008	9
4593009	10
4593010	11
4593011	12

TUBO ISOLAMENTO



REFERÊNCIA	Di	De
4592001	4	5
4592002	5	6
4592003	6	7
4592004	7	8
4592005	8	9
4592006	9	10
4592007	10	11

TUBO CHAUFAGEM



REFERÊNCIA	Di
4590001	25
4590002	32
4590003	35
4590004	38
4590005	40
4590006	42
4590007	45
4590008	50
4590009	55
4590010	60
4590011	65
4590012	70
4590013	75
4590014	80



DÚVAL TEIXEIRA LOPES

PRODUTOS DE BORRACHA

TUBO RADIADOR A METRO



REFERÊNCIA	Di	De
4591001	18	24
4591002	20	26
4591003	22	28
4591004	25	32
4591005	28	35
4591006	30	38
4591007	32	40
4591008	35	43
4591009	38	47
4591010	40	49
4591011	42	51
4591012	45	54
4591013	48	57
4591014	50	60
4591015	52	63
4591016	55	65
4591017	60	72
4591018	65	77
4591019	70	82
4591020	76	87
4591021	80	94
4591022	90	104
4591023	100	115
4591024	110	122

TUBO TUBANO



REFERÊNCIA	Di
4590051	25
4590052	31.5
4590053	33.5
4590054	37
4590055	44
4590056	48
4590057	57

FOLHA NATURAL PRETA SEM TELA



REFERÊNCIA	e
4599001	2
4599002	3
4599003	4
4599004	5
4599005	6
4599007	8

TUBO RADIADOR CURVO DE 90 GRAUS



REFERÊNCIA	Di	De
4596001	10	17
4596002	12	19
4596003	15	22
4596004	18	27
4596005	22	31
4596006	25	34
4596007	28	37
4596008	30	39
4596009	32	41
4596010	35	44
4596011	38	47
4596012	40	49
4596013	45	54
4596014	50	59
4596015	55	64
4596016	60	69

FOLHA NATURAL PRETA COM UMA TELA



REFERÊNCIA	e
4599012	2
4599013	3
4599014	4

FOLHA NATURAL PRETA COM DUAS TELAS



REFERÊNCIA	e
4599015	5
4599016	6
4599017	8
4599018	10
4599019	12

FOLHA NATURAL BRANCA COM DUAS TELAS



REFERÊNCIA	e
4599020 uma tela	2
4599021	3
4599022	4
4599023	5
4599024	6
4599025	8
4599026	10
4599027	12

FOLHA NEOPREN



REFERÊNCIA	e
4599036	2
4599037	3
4599038	4
4599039	5
4599040	6
4599041	8
4599042	10
4599043	12

FOLHA NITRILICA



REFERÊNCIA	e
4599028	2
4599029	3
4599030	4
4599031	5
4599032	6
4599033	8
4599034	10
4599035	12



DÚVAL TEIXEIRA LOPES

PRODUTOS DE BORRACHA

PLACA NATURAL



REFERÊNCIA	e
4599044	15
4599045	20
4599046	25
4599047	30
4599048	35
4599049	40
4599050	45
4599051	50

PLACA NEOPREN



REFERÊNCIA	e
4599060	15
4599061	20
4599062	25
4599063	30
4599064	35
4599065	40
4599066	45
4599067	50

PLACA NITRÍLICA



REFERÊNCIA	e
4599052	15
4599053	20
4599054	25
4599055	30
4599056	35
4599057	40
4599058	45
4599059	50

PAVIMENTO CANELADO LARGO



4599072

PAVIMENTO CHECKER PRETO



4599071

PAVIMENTO ESTRIADO PRETO



4599069

PAVIMENTO ESTRIADO CANELADO PRETO



4599070

PAVIMENTO MOEDA PRETO



4599068

PAVIMENTO PITONADO

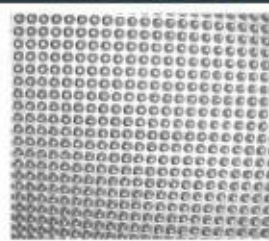

4599073



DÚVAL TEIXEIRA LOPES

PRODUTOS DE BORRACHA

FOLHA BORRACHA ANTI-ABRASIVA



REFERÊNCIA	e
4599074	3
4599075	4
4599076	5
4599077	6
4599078	8
4599079	10
4599080	12

FOLHA BORRACHA CREPE



REFERÊNCIA	e
4599081	1
4599082	2
4599083	3
4599084	4
4599085	5
4599086	6
4599087	8
4599088	10



PALAS DE CAMIÃO	
	VOLVO
4450090	C-600 L-340

PALAS DE CAMIÃO	
	SCANIA
4450091	C-600 L-340

PALAS DE CAMIÃO	
	DAF
4450092	C-600 L-340

PALAS DE CAMIÃO	
	MAN
4450093	C-600 L-340

PALAS DE CAMIÃO	
	MERCEDES
4450094	C-600 L-340

PALAS DE CAMIÃO	
	RENAULT
4450095	C-600 L-340

PALAS DE CAMIÃO	
	IVECO
4450096	C-600 L-340

PALAS DE CAMIÃO	
	
4450097	C-600 L-340



PALAS DE CAMIÃO RODADO SIMPLES	
	
4450098	
	C-310 L-263

PALAS DE CAMIÃO RODADO DUPLO	
	
4450099	
	C-335 L-450

PALAS DE FURGÃO UNIVERSAL	
	
4450100	
	C-350 L-255

JOGO DE PALAS CITROEN	
	AX
4510065	
	A-292 L-217

JOGO DE PALAS FIAT UNO	
	
4520130	
	C-375 L-211

JOGO DE PALAS LINEACESSORI	
	
4520130.1	
	C-370 L-205

JOGO DE PALAS RENAULT	
	SUPER 5 R21 EXPRESS
4530188	
	C-335 L-210

JOGO DE PALAS RENAULT	
	R19
4530189	
	A-255 L-208



JOGO DE PALAS RENAULT	
 CLIO	
4530190	
	A-257 L-258

JOGO DE PALAS OPEL CORSA APÓS 93	
	
4540052	
	C-335 L-200

JOGO DE PALAS OPEL CORSA ANTES 93	
	
4540053	
	C-410 L-217

JOGO DE PALAS VOLKSWAGEN	
 GOLF	
4560085	
	A-415 L-190

JOGO DE PALAS FORD FIESTA	
	
4570074	
	C-368 L-201

JOGO DE PALAS PEUGEOT	
 PEUGEOT	
4580089	
	C-265 L-192

JOGO DE PALAS UNIVERSAL - FRENTE	
	
4593050	
	C-297 L-168

JOGO DE PALAS UNIVERSAL - TRÁS	
	
4593051	
	C-302 L-200



JOGO DE PALAS UNIVERSAL - JEEP



4593052

A-490 L-310



APOIO ANTERIOR INFERIOR DO MOTOR	
	145 146 155 1.9 TD após 96 155 2.5 TD após 96 156 1.6 - 1.8 - 2.0
4520024	
7642540 60808861 7652240 60594600	ØF-17.5 ØFr-11 A-67.5 L-102

APOIO POSTERIOR DO MOTOR	
	GTV 2.0 Twin Spark NOVO SPIDER
4520024	
7642540 60808861 7652240 60594600	ØF-17.5 ØFr-11 A-67.5 L-102

APOIO SUPERIOR ESQUERDO DO AMORTECEDOR DA SUSPENSÃO ANTERIOR	
	145/146 2.0 I.E. Twin Spark 145/146 1.9 TD 155
4520035	
60809753 46414184 60811373	ØF-12 ØFr-3xM7

APOIO SUPERIOR DIREITO DO AMORTECEDOR DA SUSPENSÃO ANTERIOR	
	145/146 2.0 IE Twin Spark 145/146 1.9 TD 155
4520099	
60811372 60809752 46414183	ØF-12 ØFr-3xM7

BATENTE DA BARRA ESTABILIZADORA ANTERIOR	
	145/146 155 após 96 164 GTV
4520109	
60806408	ØE-31 ØF-10 A-19

TAMPA DA VARETA DO ÓLEO	
	145/146 1.3 - 1.6 - 1.7 164 SUPER Gas.
4520045	
60807644 4102056 4328493	ØE-17 A-42

BOTÃO DE CAPOT	
	ALFASUD
4525011	
100816	ØE-17 A-43

SUPORTE DO TUBO DE ESCAPE	
	145 146 155 1.9 TD sem catalizador após 96 155 2.5 TD sem catalizador após 96
4520016	
5989798 60806020	C-59.8 L-44.2



SUPORTE DO TUBO DE ESCAPE 1ª SECÇÃO	
	145/146 2.0 155 após 92
4520096	
60811858	∅F-2x8 A-26 C-55 L-38

SUPORTE DO TUBO DE ESCAPE	
	155 4x4 TURBO GTV 2.0 TWIN SPARK NOVO SPIDER
4525005	
60807479	A-27.5 C-54 L-44

ANEL DE ESCAPE	
	75 90 145/146 TD 155 1.9TD - 2.5TD 164 D FL - SUPER ALFETTA GIULIETTA
4545023	
116003008300 60806026 60801572	∅E-63 A-15

SUPORTE ANTERIOR DO ESCAPE	
	33 NOVO 33 TD até 5/90 SUD
4565001	
530355 60504209	∅P-6 A _P -14.5 C-46.5 L-20.5

ESTICADOR DE ESCAPE	
	33 - NOVO 33 TD 75 - 90 145/146 155 após 96 164 Turbo 2.0 - 164 FI92 SUD
4565003	
102866 102508 60503033 60573784	∅E-54.5 ∅S-14.5

SUPORTE CENTRAL DO TUBO DE ESCAPE	
	75 90 ALFASUD ALFETTA GIULIETTA
4565006	
60521407	∅F-2x12 A-37 C-93 L-39.5

FOLE DO SEMI-EIXO DIFERENCIAL LADO DA RODA	
	NOVO 33 1.3 - 1.5 NOVO 33 I.E. 8V até 11/91 145/146 155 164 FL92 GTV 2.0 Twin Spark
4520029	
60808619	∅F _G -78 ∅F _P -24 A-99

FOLE DO SEMI-EIXO DIFERENCIAL LADO DA RODA	
	NOVO 33 até 10/91 NOVO 33 1.3 - 1.5 NOVO 33 1.3 IE 8V - 1.5 IE 8V NOVO 33 1.7 IE 8V 155 TWIN SPARK 164 2.0 TWIN SPARK
4560045	
60562336	∅F _G -83 ∅F _P -22 A-84



FOLE DO SEMI-EIXO DIFERENCIAL LADO DA RODA	
	33 1.3 ALFASUD ARNA 1.2
4560057	
700160 60748291	ØF _G -75 ØF _P -20 A-83

FOLE DO SEMI-EIXO DIFERENCIAL LADO DA CAIXA DE VELOCIDADES	
	33 até 90 NOVO 33 até 90 145/146 ARNA SUD
4565004	
60548963 60748583	ØF _G -51 ØF _P -22 A-81

FOLE DA CAIXA DA DIRECÇÃO	
	33 NOVO 33 ALFASUD ARNA
4565005	
60502781 102962 60709447	ØF _G -43 ØF _P -40 A-140

FOLE DO SEMI-EIXO DIFERENCIAL LADO DA RODA	
	33 1.5 4x4 33 1.8 TD ARNA 1.3
4565007	
705089 60749591	ØF _G -84 ØF _P -19 A-74

SILENT-BLOC ANTERIOR DO BRAÇO DE SUSPENSÃO ANTERIOR	
	145/146 155 GTV NOVO SPIDER
4520052	
7601064	ØF-20 ØF _R -9 L-49.5

SILENT-BLOC POSTERIOR DO BRAÇO DIREITO DA SUSPENSÃO ANTERIOR	
	145/146 155 GTV NOVO SPIDER
4520058	
7601068	ØF-19.9 ØF _R -10 L-52

SILENT-BLOC CENTRAL DA BARRA ESTABILIZADORA ANTERIOR	
	155
4520060	
7601646	ØF-23 A-47.5 C-41 L-60

SILENT-BLOC POSTERIOR DO BRAÇO DE SUSPENSÃO ANTERIOR ESQUERDA	
	145/146 155 GTV NOVO SPIDER
4520064	
7601065	ØF-19.8 ØF _R -10 A-60 L-52.5



TUBO INFERIOR DE SAÍDA DE ÁGUA DO RADIADOR	
	145/146 2.0 IE TWIN SPARK 155 2.0 TWIN SPARK 155 2.5 V6
4570068	
60603082	ØF-31.5 ØF-31.5

SUPORTE ANTERIOR DO MOTOR	
	80 1.6 de 6/86 a 7/91 80 2.0 de 6/86 a 7/91
4560010	
823199381B 893199381B	ØP-10 A _P -23 ØP-10 A _P -21 A-59 C-63.5 L-87

APOIO INFERIOR DO AMORTECEDOR ANTERIOR - COM ROLAMENTO	
	80
4560033	
871412323A	ØE-76 ØF-20.5 ØF-12 A-42

APOIO SUPERIOR DO AMORTECEDOR ANTERIOR - COM ROLAMENTO	
	80 80 D até 89
4560043	
811412323C	ØE-76 ØF-14 ØF-21 A-42

BATENTE LATERAL DA BARRA ESTABILIZADORA ANTERIOR	
	80
4560032	
823411313A	ØF-12.5 A-43.5 C-40.5 L-24.5

BATENTE CENTRAL DO AMORTECEDOR ANTERIOR	
	80 até 7/91
4575007	
811412131B 893412131B	ØE-52 A-65

CASQUILHO ANTERIOR DO MOTOR	
	80 1.6 desde 8/86 80 2.0 desde 8/86 100 2.3 desde 8/89 100 2.4D desde 8/89 100 2.5D desde 8/89
4575006	
893199339	ØE-48.2 ØF-26 A-46.7

CAPA DE PEDAL DO TRAVÃO E EMBRAIAGEM	
	80 de 82 a 7/86
4560014	
321721173	A-10 C-66 L-55

CAPA DE PEDAL DO TRAVÃO E EMBRAIAGEM	
	80 L até 82 80 S até 82 80 SL até 82 80 GL até 82
4560015	
823721173	A-9.5 C-60 L-50.5



ANEL DE ESCAPE	
	80 100 L · LS · GL · GLS
4545023	
861253147 823104590 823104595	ØE-63 A-15

SUPORTE DO TUBO DE ESCAPE	
	80 100
4575008	
431253147	A-13 C-63 L-52

SUPORTE POSTERIOR DO TUBO DE ESCAPE	
	80 Modelos '92 e '93
4575009	
8A0253144E	A-66 C-132.5 L-26

ESTICADOR ESCAPE	
	A4 após 94 A6 após 98
4575010	
8D0253144 · 8D0253144K 8D0253144R · 8D0253144AE	A-66 C-112 L-30.5

ESTICADOR ESCAPE	
	A4 após 94 A6 após 98
4575011	
8D0253144A 8D02531445	A-65 C-120 L-29.5

FOLE DO SEMI-EIXO DIFERENCIAL LADO DO RODA	
	80 QUATTRO 100 100 AVANT 100 COUPÉ 100 QUATTRO
4540021	
443407285A	ØF _G -82 ØF _P -22 A-78

FOLE DIREITO DO SEMI-EIXO DIFERENCIAL LADO DA CAIXA DE VELOCIDADES	
	80 AUTOMATIC 5 cil. após 9/84
4560035	
191407283 191498202	ØF _G -100 ØF _P -36 A-120

FOLE DO SEMI-EIXO DIFERENCIAL LADO DA RODA	
	80 GT de 82 a 84 80 GTE de 82 a 84 100 AVANT 100 COUPÉ 100 S 100 GT
4560045	
60562336	ØF _G -83 ØF _P -22 A-84



FOLE DO SEMI-EIXO DIFERENCIAL LADO DA CAIXA DE VELOCIDADES	
	50 80 GTE - GTS 90 100 100 AVANT - 100 QUATTRO 200 200 AVANT - 200 QUATTRO
4560055	
211501149 211598201	ØF _G -100 ØF _P -21 A-100

FOLE DO SEMI-EIXO DIFERENCIAL LADO DA RODA	
	80 Gas. após 81 100 GL 100 GT5S 100 COUPÉ
4560057	
321407285B	ØF _G -75 ØF _P -20 A-83

SILENT-BLOC DO BRAÇO SUSPENSÃO ANTERIOR VIATURAS COM DIRECÇÃO ASSISTIDA	
	80 após 86 90 após 86
4575001	
857407181	ØE-37 ØE _A -48 ØF-10 A-44

FOLE DO SEMI-EIXO DIFERENCIAL LADO DA CAIXA DE VELOCIDADES	
	80 viatura com 4 cilindros 100 100 QUATTRO
4560062	
113501149 443407283	ØF _G -94 ØF _P -20 A-78.5

TUBO DE LIGAÇÃO DA BOMBA DE ÁGUA AO TERMOSTATO	
	80 D
4575002	
068121053M 068121053Q	ØF-24

TUBO DE LIGAÇÃO DA BOMBA DE ÁGUA AO TERMOSTATO	
	80 Gas. 100 1.6 100 1.8
4560049	
026121053A 026121053F 026121053G	ØF-24 ØF-24

TUBO SUPERIOR DO RADIADOR	
	80 D de 8/81 a 1/84
4575004	
811121101A 811121101H	ØF-30

TUBO INFERIOR DE SAÍDA DE ÁGUA DO RADIADOR	
	80 até 81
4575003	
811121051	ØF-30



APOIO ANTERIOR DO MOTOR LADO DA DISTRIBUIÇÃO	
	Y10 FL89 velocidades automáticas
4520032	
7653188 7667850	ØF-12.3 A-54 C-133 L-80

SUPORTE POSTERIOR DO MOTOR	
	Y10
4520107	
7544643	ØF-8.5 ØF-2x16 A-64.5 C-131 L-80

CASQUILHO DA EXTREMIDADE DA CREMALHEIRA DA DIRECÇÃO	
	A112 Y10 após 91 e exepto 4x4
4525013	
4179805 4330731	ØF-20.5 A-18.5 C-28 L-28

CAPA DE PEDAL DO ACELERADOR	
	A112
4520013	
4187379 SE021110044A	C-96.5 L-43.5

CAPA DE PEDAL DO TRAVÃO E EMBRAIAGEM	
	A112 Y10
4520014	
4144275	C-64.5 L-50

CAPA DE PEDAL DO TRAVÃO E EMBRAIAGEM	
	A112 após 1/73 Y10
4520056	
4144275	C-64 L-50.5

TAMPA DA VARETA DO ÓLEO	
	A111 A112 PRIMULA Y10 até 91
4520045	
60807644 4102056 4328493	ØE-17 A-42

BOTÃO DE CAPOT	
	A112 Y10 após 91
4525011	
4276430	ØE-17 A-43



SUPORTE DO TUBO DE ESCAPE	
	Y10 4x4
4520016	
5989798 60806020	C-59.8 L-44.2

ESTICADOR DE ESCAPE	
	Y10
4520030	
7600807	A-42 C-67.5 L-44.5

ESTICADOR DE ESCAPE	
	A112 Y10 4x4
4520051	
4296059 4312280	∅F-6.5 A-33.5 C-79.5 L-36

SUPORTE POSTERIOR DO TUBO DE ESCAPE	
	Y10 após 91 Y10 exepcto 4x4
4525005	
4387293	A-27.5 C-54 L-44

SUPORTE CENTRAL DO TUBO DE ESCAPE	
	PRIMULA
4565006	
60521407	∅F-2x12 A-37 C-93 L-39.5

FOLE DO SEMI-EIXO DIFERENCIAL LADO DA CAIXA COM CASQUILHO DE NYLON	
	A112 de 12/84 a 2/86 Y10 até 9/86
4520028	
92601255	∅F _G -71 ∅F _P -23 A-73

FOLE ESQUERDO DO SEMI-EIXO DIFERENCIAL COM CASQUILHO DE NYLON - LADO DA CAIXA	
	A112 de 12/84 a 2/86 Y10 até 2/86
4520036	
	∅F _P -25

FOLE DO SEMI-EIXO DIFERENCIAL LADO DA RODA	
	A112 após 5/85 Y10 até 12/88
4520038	
5987092	∅F _G -68 ∅F _P -20 A-80



FOLE DIREITO DA DIRECÇÃO	
	A112 Y10
4520040	
4239459 4371156	ØF _G -26 ØF _P -10 A-165

FOLE DO SEMI-EIXO DIFERENCIAL LADO DA CAIXA DE VELOCIDADES	
	Y10 RL92 1.1 IE Y10 ELITE
4520041	
7746232	ØF _G -60 ØF _P -19 A-90

FOLE DO SEMI-EIXO DIFERENCIAL LADO DA CAIXA DE VELOCIDADES	
	A112 de 11/82 a 11/84
4520046	
92601216 92601171	ØF _G -64 ØF _P -23 A-73

FOLE DIREITO DO SEMI-EIXO DIFERENCIAL LADO DA CAIXA DE VELOCIDADES	
	Y10 até 9/87
4520046	
92601216 92601171	ØF _G -64 ØF _P -23 A-73

FOLE DO SEMI-EIXO DIFERENCIAL LADO DA CAIXA DE VELOCIDADES	
	Y10 após 10/87
4520054	
7625541	ØF _G -80 ØF _P -30 A-82

FOLE ESQUERDO DA DIRECÇÃO	
	A112 Y10
4520063	
4239458 4371155	ØF _G -42 ØF _P -10 A-125

FOLE ESQUERDO E DIREITO DO SEMI-EIXO DIFERENCIAL LADO DA RODA	
	Y10
4520071	
7682886	ØF _G -65 ØF _P -19.5 A-81

FOLE ESQUERDO DO SEMI-EIXO DIFERENCIAL LADO DA CAIXA DE VELOCIDADES	
	A112 após 3/86 Y10 de 3/86 a 9/87
4520072	
92601366	ØF _G -79 ØF _P -23 A-75



FOLE DIREITO DO SEMI-EIXO DIFERENCIAL LADO DA CAIXA DE VELOCIDADES	
	Y10 após 10/87
4520085	
7621245	ØF _G -74 ØF _P -30 A-85

KIT FOLE DO SEMI-EIXO DIFERENCIAL LADO DA CAIXA DE VELOCIDADES - EIXO 23mm	
	Y10 após 10/87
4520087	
	ØF _G -30 ØF _P -80 A-82

KIT FOLE DO SEMI-EIXO DIFERENCIAL LADO DA CAIXA DE VELOCIDADES - EIXO 23mm	
	Y10 após 10/87
4520088	
	ØF _G -74 ØF _P -30.5 A-86

FOLE CENTRAL DO AMORTECEDOR ANTERIOR	
	Y10
4520122	
5978771	ØF _G -58 ØF _P -18 A-190

FOLE DO SEMI-EIXO DIFERENCIAL LADO DA CAIXA DE VELOCIDADES	
	A112
4520127	
4333088	ØF _G -64 ØF _P -25 A-85



APOIO ANTERIOR DO MOTOR	
	Desde 8/78 Até 8/79
	315 518 316 520 320 526 326 M535i 323i 324D 325E
4550001	
11811132321 11811175212	∅P-10 A _P -35.5 A _P -22.5 ∅E-69.5 A-47

APOIO ANTERIOR DO MOTOR	
	316 - 316S - 316i - 316i M40 318i - 318i M40 320i 323i 325E - 325i
4550007	
11811129286 11811176387	∅P-2x10 A _P -2x19 A-51.5 C-78 L-50

SUPORTE POSTERIOR DA CAIXA DE VELOCIDADES	
	315 - 316 - 318 - 318i - 320 320i - 323i - 324 - 324i - 326 518 até 7/81 520
4550008	
23711175424 23711109173	∅E-50 ∅P-2x10 A _P -15/32 A-32.5

SUPORTE CENTRAL DA TRANSMISSÃO COM ROLAMENTO	
	315 - 316 - 318 - 318i 320 - 320i - 323i - 324 - 324i 326 - 326i 518 - 520 - 525 - 528 - M535i 1502 - 1602 - 1802 - 2002
4550011	
26121104355 26111206502	∅F-30 A-98 C-157 L-39

TACO DE NYLON PARA SUPORTES DE TUBOS DE ESCAPE	
	Série 3 Série 5 E12 E21 Todos E24 628 CSI - 630 CS E24 633 CSI - 835 CSI 1600 - 1602 - 1802 - 2002
4550004	
18214490157	A-21 C-39.5 L-25.5

ANEL DE ESCAPE	
	316 - 320 518 - 520 2500 - 2800
4545023	
18211101878 18211245113	∅E-63 A-15

SUPORTE DO TUBO DE ESCAPE	
	Série 3 518 - 520 - 525 - 535 628 - 630 - 633 CSI
4550002	
18211245985	∅E-78 ∅F-43 A-38.5

SUPORTE DO TUBO DE ESCAPE	
	Série 3 Série 5 E28 - E34 628 - 630 - 633 CSI 1500 - 1502 - 1600 - 1602 1800 - 2000 - 2002
4550003	
18211115638 18211115677 18214490159	∅E-64.5 A-20.5

SUPORTE DO TUBO DE ESCAPE	
	316 318 325 TD
4550009	
	A-16 C-84 L-84

FOLE ESQUERDO DA DIRECÇÃO VIATURAS COM DIRECÇÃO ASSISTIDA	
	316 318i 320i 323i 324D 324TD
4550005	
32111117426	∅F _G -53 ∅F _P -53 A-126

FOLE DIREITO DA DIRECÇÃO VIATURAS COM DIRECÇÃO ASSISTIDA	
	315 Fole esquerdo e direito 316 318 320 323i
4550006	
32111118688 32111125131	∅F _G -44 ∅F _P -39 A-165

FOLE DO SEMI-EIXO DIFERENCIAL LADO DA RODA E CAIXA DE VELOCIDADES	
	1500 · 1502 · 1600 · 1602 1800 · 1802 · 2000 · 2002 2500 · 2800 · 3000 316 · 318 · 320 · 320i · 323i 518 · 520 · 524 · 526
4565004	
33211105446 33211207036	∅F _G -51 ∅F _P -22 A-81

TUBO SUPERIOR DE ENTRADA DE ÁGUA DO RADIADOR	
	315 · 316 · 318 · 318i 320 4 cil. · 324 4cil. 320i 4 cil. · 324i 4cil. 518 · 520 · 520i 524 · 524i M535i
4550010	
11531266464 11531262751	∅F-30 ∅F-30



CASQUILHO	
	BPW
4450011	
05.113.96.05.0	∅E-59 ∅F-30 A-68

CASQUILHO	
	BPW
4450012	
	∅E-60 ∅F-30 A-68

CASQUILHO DE MOLAS	
	BPW
4450049	

APOIO DA SUSPENSÃO DO MOTOR	
	BX 1.4 C15
4510002	
91504873	∅P-10 A _P -38.5 A _P -14.5 C-96.5 L-76

APOIO INTERMÉDIO DA SUSPENSÃO ANTERIOR	
	AX ZX
4510006	
97521102	∅F-10 A-31 C-88 L-40

APOIO POSTERIOR DO MOTOR	
	C25
4510008	
91504873	∅F-12 L-73

SUPORTE ANTERIOR DIREITO DO MOTOR	
	AX D BX 1.6 BX D VISA D VISA GT ZX D C15 D
4510012	
91517554	∅P-10 A _P -32 A _P -22 ∅E-81.5 A-79

SUPORTE HIDRAULICO ANTERIOR DIREITO DO MOTOR	
	AX D BX 1.6 BX D VISA D VISA GT ZX D C15 D
4510012.1	
91517554	∅P-10 A _P -32 A _P -22 ∅E-81.5 A-79

APOIO EXTERIOR DO BRAÇO DA SUSPENSÃO	
	AX
4510022	
96106474	∅F-16.8 ∅P-10 A _P -27.5 C-84.5 L-55

SILENT-BLOC EXTERIOR DO BRAÇO DE SUSPENSÃO	
	ZX
4510024	
	∅F-18.7 ∅F _R -8 L-38.1

APOIO ANTERIOR DO MOTOR	
	AX 1.0 AX 1.1
4510029	
95631679	∅P-10 A _P -23.5 A _P -24.5 A-58.5 C-42 L-42



APOIO SUPERIOR DO AMORTECEDOR DIANTEIRO	
	AX
4510031	
95603783	ØF-30 ØP-8 A _P -20 C-125 L-100

SUPORTE DIREITO DO MOTOR	
	BX LNA VISA 954 - 1124 VISA 1360 GT C15 Gas.
4510062	
7910032165	ØP-2x10 A _P -2x25.5 A-48 C-66 L-41

APOIO ANTERIOR ESQUERDO DO MOTOR	
	BX 1.6 BX D VISA GT VISA D ZX D C15 D
4580010	
96033565 91521643	ØF-12.5 A-43 C-100.5 L-70

SUPORTE MOTOR	
	BX D VISA C15
4580058	
91535412	ØP-8 A _P -26.5 A-26 C-49.5 L-44

APOIO ANTERIOR DIREITO DO MOTOR	
	AX 1.1 IE
4580063	
96096563	A _P -2x20.5 ØF-10.5 ØP-2x8 A-56 C-126 L-70

BATENTE DA BARRA ESTABILIZADORA	
	AX
4510030	
96064489 96054483	ØF-19 C-34 L-24

BATENTE CENTRAL DA BARRA ESTABILIZADORA	
	AX
4510033	
96054481	ØF-18.5 A-42 C-56 L-41

BATENTE SUPERIOR DO AMORTECEDOR ANTERIOR	
	AX
4510051	
95603785	ØF _G -23 ØF _P -22 ØE-52.5 A-79



BATENTE DA BARRA ESTABILIZADORA ANTERIOR - BRANCA	
	VISA C15
4580030	
	ØF-20 A-32 C-55.5 L-39

BATENTE DA BARRA ESTABILIZADORA ANTERIOR - VERDE	
	VISA C15
4580031	
	ØF-20 A-32.5 C-55 L-39.5

BATENTE DA BARRA ESTABILIZADORA ANTERIOR - AZUL	
	VISA C15
4580032	
	ØF-23 A-32 C-55.5 L-39

CAPA DE PEDAL DO TRAVÃO E EMBRAIAGEM	
	AX BX 1ª Série DYANE GS
4510013	
95575913	C-69.5 L-45

CAPA DE PEDAL DO TRAVÃO E EMBRAIAGEM	
	XANTIA XM
4510015	
9603694380	C-82 L-43

CAPA DE PEDAL DO TRAVÃO E EMBRAIAGEM	
	2CV AX BX ZX C15
4510016	
95575913	C-68 L-45.5

CAPA DE PEDAL DO TRAVÃO E EMBRAIAGEM	
	CF 15
4510017	
9153649780	C-103 L-68.5

CARDAN DA DIRECÇÃO	
	LN LNA VISA GT VISA L VISA SUPER C15
4580016	
7910014811	ØE-75 ØF-4x8 A-11.5

ESTICADOR DE ESCAPE	
	BX 1.4 BX 1.6 BX 1.9 C15
4510001	
95576338	A-24.75 C-64.5 L-45

ESTICADOR DE ESCAPE	
	XANTIA XM ZX
4510019	
96037651	A-37 C-70.5 L-45.5

SUPORTE CENTRAL DO TUBO DE ESCAPE	
	BX 1.4 BX 1.6 BX 1.9 GS C15
4510052	
95576338	∅F-2x9 A-45 C-44 L-44

ESTICADOR DE ESCAPE	
	AX C15
4510066	
	A-30 C-60 L-55

ANEL DE ESCAPE	
	CX VISA GT C15 C25
4545023	
5460614A	∅E-63 A-15

ESTICADOR DE ESCAPE	
	VISA
4565003	
102866 102508 60503033 60573784	∅E-54.5 A-14.5

SUPORTE CENTRAL DO ESCAPE	
	BX 1.4 - 1.6 - 1.9 C15
4580008	
95576338	A-39.5 C-65 L-45

FOLE DO SEMI-EIXO DIFERENCIAL LADO DA CAIXA DE VELOCIDADES	
	AX 1.0 AX 1.1
4510014	
95653092	∅Fg-63 ∅Fp-20 A-155



FOLE DO SEMI-EIXO DIFERENCIAL LADO DA CAIXA DE VELOCIDADES	
	CX 2.5 TURBO C25
4510032	
95613146 95569341	ØF _G -94 ØF _P -24 A-103

FOLE DO SEMI-EIXO DIFERENCIAL LADO DA RODA	
	AX até 2/93
4510036	
95619710	ØF _G -73 ØF _P -19 A-82

FOLE DIREITO E ESQUERDO DA DIRECÇÃO	
	BX 1.1 BX 1.4 só lado direito BX 1.6 BX 1.9
4510044	
95495914	ØF _G -47 ØF _P -11 A-200

FOLE DO SEMI-EIXO DIFERENCIAL LADO DA RODA	
	VISA SPECIAL C15
4510045	
95532950	ØF _G -71 ØF _P -18 A-111

FOLE DO SEMI-EIXO DIFERENCIAL LADO DA RODA	
	XANTIA XM
4510046	
95653007	ØF _G -90 ØF _P -24 A-104

FOLE DO SEMI-EIXO LADO DA CAIXA DE VELOCIDADES	
	BX 1.6 BX 1.9 XANTIA XM ZX TD C15 D
4510047	
95025088 95590841 95653006	ØF _G -75 ØF _P -22 A-100

FOLE DO SEMI-EIXO DIFERENCIAL LADO DA RODA	
	C25
4510048	
95569342	ØF _G -95 ØF _P -24 A-150

FOLE DO SEMI-EIXO DIFERENCIAL LADO DA CAIXA DE VELOCIDADES	
	SAXO C15
4510049	
65590794 95619709	ØF _G -70 ØF _P -20 A-170



FOLE DO SEMI-EIXO DIFERENCIAL LADO DA RODA	
	BX 1.1 - 1.4 - 1.9 BX 1.6 até 87 BX D - 1.9 TD VISA ZX 1.1 - 1.6 - 1.9 ZX TD C15
4510053	C15
95549619 95570874 95578824 95590840	ØF _G -77 ØF _P -22 A-79

FOLE ESQUERDO DA DIRECÇÃO VIATURAS COM DIRECÇÃO ASSISTIDA	
	XM ZX
4510063	
95639176	ØF _G -43 ØF _P -43 A-118

FOLE DO SEMI-EIXO DIFERENCIAL LADO DA RODA	
	C25
4520037	
95569342 95653068	ØF _G -92 ØF _P -24 A-145

FOLE ESQUERDO DA DIRAECÇÃO	
	C25
4520073	
	ØF _G -49 ØF _P -11 A-155

FOLE DIREITO DA DIRECÇÃO	
	C25
4520081	
	ØF _G -38 ØF _P -11.5 A-215

FOLE DIREITO E ESQUERDO DA DIRECÇÃO	
	LN LNA VISA 1124cc - 1219cc - 1360cc VISA DIESEL VISA SUPER ZX com direcção assistida ZX DX e SX sem direcção assistida
4580067	
91510923	ØF _G -40 ØF _P -10 A-175

FOLE DO SEMI-EIXO DIFERENCIAL LADO DA RODA	
	BX 1.6 após 87 BX D ZX 1.6 ZX D
4580070	
3293.83	ØF _G -82 ØF _P -20 A-105

FOLE DO SEMI-EIXO DIFERENCIAL LADO DA RODA	
	ZX 1.1 ZX 1.4
4580079	
3293.77	ØF _G -82 ØF _P -19 A-85

JOGO DE PALAS CITROËN	
	AX
4510065	
	A-292 L-217

SIELNT-BLOC DO APOIO TRASEIRO DO MOTOR	
	AX D BX D VISA D ZX D C15 D
4510007	
915071180	ØE-70 ØF-10 Aε-40 A-53

SILENT-BLOC DO APOIO 4510008	
	C25
4510009	
	ØE-70 ØF-12 Aε-50 A-64

SILENT-BLOC CENTRAL DO BRAÇO DA SUSPENSÃO	
	AX
4510020	
95603308	ØE-34.1 ØF-12 Aε-30 A-48

SILENT-BLOC EXTERIOR DO BRAÇO DA SUSPENSÃO	
	AX
4510021	
96133255	ØF-14 A-40 C-53 L-45

SILENT-BLOC CENTRAL DO BRAÇO DA SUSPENSÃO	
	ZX
4510023	
	ØE-33 ØEa-44 ØF-12 A-31

SILENT-BLOC DA BIELA TIRANTE DO MOTOR	
	VISA ZX 1.1 - 1.4 C15
4510055	
91201175	ØE-30 ØF-12 Aε-28 A-34

SILENT-BLOC POSTERIOR DO MOTOR	
	ZX D - TD
4510064	
1809.22	ØE-30 ØF-10 Aε-28 A-50

SILENT-BLOC DO BRAÇO SUSPENSÃO ANTERIOR	
	VISA C15
4580022	
91515653	ØE-36 ØEA-48 ØF-12 A-25

SILENT-BLOC DO BRAÇO SUSPENSÃO ANTERIOR	
	VISA C15
4580023	
96096727 7910035449	ØE-28 ØF-10 A _E -28 A _I -38

SILENT-BLOC DO BRAÇO SUSPENSÃO ANTERIOR	
	VISA C15
4580027	
96096727 7910035449	ØE-28 ØF-10 A _E -28 A _I -34

SILENT-BLOC CENTRAL DO BRAÇO SUSPENSÃO ANTERIOR	
	VISA C15
4580028	
91504248 9150018980	ØE-38 ØF-14 A _E -24 A _I -42

SILENT-BLOC DA BIELA DO SUPORTE DO MOTOR	
	BX VISA ZX 1.1 - 1.4 C15
4580064	
91201175	ØE-30 ØF-12 A _E -28 A _I -34

TUBO SUPERIOR DE ENTRADA DE ÁGUA DO RADIADOR	
	ZX 1.1 ZX 1.4
4510034	
96089333	ØFG-36 ØFP-28

TUBO INFERIOR DE SAÍDA DE ÁGUA DO RADIADOR	
	VISA 1219
4510035	
95545880	ØFG-32 ØFP-30

TUBO INFERIOR DE SAÍDA DE ÁGUA DO RADIADOR	
	C15 D
4510037	
96011359	ØFG-33 ØFP-28.5



TUBO DO AQUECIMENTO	
	C15 D
4510038	
95593279 95638650	ØF _G -19.5 ØF _P -14.5

TUBO SUPERIOR DE ENTRADA DE ÁGUA DO RADIADOR	
	AX Gas. - até chassis 5314
4510039	
95636003	ØF _G -30 ØF _P -26

TUBO SUPERIOR DE ENTRADA DE ÁGUA DO RADIADOR	
	C15 D
4510040	
96011773	ØF _G -33 ØF _P -29

TUBO SUPERIOR DE ENTRADA DE ÁGUA DO RADIADOR	
	AX D
4510041	
96003397	ØF _G -28 ØF _P -26

TUBO DO AQUECIMENTO - 1ª SECÇÃO	
	AX
4510042	
96058717	ØF _G -17.5 ØF _P -16.5

TUBO INFERIOR DE SAÍDA DE ÁGUA DO RADIADOR	
	AX 1º Tipo AX SPORT
4510043	
95206756	ØF _G -30 ØF _P -26

TUBO INFERIOR DE SAÍDA DE ÁGUA DO RADIADOR	
	ZX 1.1 ZX 1.4
4510050	
1351-J4	ØF-32 ØF-31

TUBO INFERIOR DE SAÍDA DE ÁGUA DO RADIADOR	
	BX 1.7D - 1.9D
4510054	
95587690	ØF-34 ØF-30



TUBO SUPERIOR DE ENTRADA DE ÁGUA DO RADIADOR	
	ZX D
4510056	
1343-L3	ØF-39 ØF-31

TUBO SUPERIOR DE ENTRADA DE ÁGUA DO RADIADOR	
	BX 1.1 - 1.4
4510057	
95566628	ØF-33 ØF-30

TUBO SUPERIOR DE ENTRADA DE ÁGUA DO RADIADOR	
	BX 1.6 - 1.9
4510058	
95581253	ØF-30 ØF-30

TUBO SUPERIOR DE ENTRADA DE ÁGUA DO RADIADOR	
	AX Gasolina
4510059	
96083171	ØF-30 ØF-26

TUBO SUPERIOR DE ENTRADA DE ÁGUA DO RADIADOR - VIATURAS COM AR CONDICIONADO	
	ZX 1.4
4510060	
96089334	ØF-37 ØF-30

TUBO INFERIOR DE SAÍDA DE ÁGUA DO RADIADOR	
	BX 1.1 - 1.4
4510061	
95566627	ØF-30 ØF-30



SEPARADOR DE MOLAS PEQUENO	
	DAF
4450106	
	ØE-75 A-16.5

SEPARADOR DE MOLAS GRANDE	
	DAF
4450107	
	ØE-85 A-16

CASQUILHO DA BARRA ESTABILIZADORA	
	DAF 2500 - 2800
4450076	

PALAS DE CAMIÃO	
	DAF
4450092	
	C-600 L-340

SILENT-BLOC DE MOLAS	
	DAF
4450063	
	ØE-68 ØF-30 A _E -101 A _F -105

SILENT-BLOC DE MOLAS	
	DAF
4450082	
	ØE-45 ØF-16 A _E -74.5 A _F -81.5

SILENT-BLOC DE MOLAS	
	DAF
4450089	
	ØE-46 ØF-22 A _E -101 A _F -106



APOIO POSTERIOR DO MOTOR	
	NOVA DUCATO R/90 TALENTO
4510008	
4456819	∅F-12 L-73

SUPORTE SUPERIOR DO AMORTECEDOR POSTERIOR	
	UNO exepto CS
4520009	
5960254 7567589	∅F-10 A-31 C-96 L-71

APOIO INFERIOR DO MOTOR	
	FIORINO
4520017	
4404613 5948309	A-53 C-140.8 L-93

APOIO ANTERIOR DO MOTOR	
	BARCETTA PUNTO 1.7 D PUNTO 1.7 TD PUNTO '97 1.7 D PUNTO '97 1.7 TD
4520023	
7753635 46431619	∅P-12 A _p -75

APOIO CENTRAL DO MOTOR	
	BRAVO/BRAVA 1.9D TEMPRA 1.6 · 1.6 Maq. TEMPRA 1.8 TEMPRA 1.9D
4520024	
7642540 60808861 7652240 60594600	∅F-17.5 ∅F _R -11 A-67.5 L-102

APOIO CENTRAL DO MOTOR	
	TIPO 1.1 com caixa automática TIPO 1.4 com caixa automática TIPO 1.6 com caixa automática TIPO D TIPO TD TIPO 1.8 16V SPORT TIPO 2.0 16V SPORT
4520024	
7642540 60808861 7652240 60594600	∅F-17.5 ∅F _R -11 A-67.5 L-102

APOIO POSTERIOR DO MOTOR LADO DO DIFERENCIAL	
	PUNTO 1.4 GT TURBO PUNTO 1.7 TD PUNTO '97 1.4 GT TURBO PUNTO '97 1.7 TD
4520025	
7748666	∅F-18 ∅F-3x16 ∅F _R -10 A-85

APOIO CENTRAL DO MOTOR	
	UNO 1.7D até viatura 0539854 UNO TURBO IE
4520026	
7567856	∅F-8.7 ∅F _R -6.5 A-45 C-145.7 L-76



APOIO POSTERIOR DO MOTOR LADO DA CAIXA DE VELOCIDADES	
	UNO 55 1100 UNO 60 1100 UNO 70 1300 UNO 900 R/89 UNO 1000 R/89 UNO 1100 R/89
4520027	
5974775	ØF-8.1 A-48 C-148.1 L-80.3

APOIO ANTERIOR DO MOTOR	
	PALIO WEEKEND 1.2 PANDA R/86 VEL. AUTO. PANDA 4x4 Maq.'91 VEL. AUTO. UNO 45 900 após 89 UNO 900 R/89 após 89 UNO 1000 R/89 após 89 UNO 1100 R/89 após 89
4520032	
7653188 7667850	ØF-12.3 A-54 C-133 L-80

APOIO SUPERIOR ESQUERDO DO AMORTECEDOR DA SUSPENSÃO ANTERIOR	
	BRAVO/BRAVA 1.4-1.6-2.0 HGT BRAVO/BRAVA até 12/95 viatura 4085696 BRAVO/BRAVA '98 1.6 BRASILE BRAVO/BRAVA '98 2.0 HGT COUPÉ
4520035	
7639244 46414184 7683364 60811373	ØF-12 ØFr-3xM7

APOIO SUPERIORESQUERDO DO AMORTECEDOR DA SUSPENSÃO ANTERIOR	
	TEMPRA TIPO DX 1.1-1.4-1.6-1.9D TIPO SX 1.1-1.4-1.6 c/ D.A. TIPO SX 1.8-1.8 16V Sport- 2.0 TIPO SX 2.0 16V Sport- 1.7D TIPO SX 1.9TD após viatura 4206178
4520035	
7639244 46414184 7683364 60811373	ØF-12 ØFr-3xM7

APOIO POSTERIOR DO MOTOR LADO DA CAIXA DE VELOCIDADES	
	TEMPRA 1.4- 1.6. TEMPRA Maq. 1.4- 1.6 TIPO 1.1-1.4-1.6-1.7D-1.9D TIPO Maq. 1.1-1.4-1.6-1.7D-1.9D
4520047	
7610157	ØF-10 A-68.5 L-110

APOIO POSTERIOR DO MOTOR LADO DA CAIXA DE VELOCIDADES	
	PANDA R/86 1.3D
4520048	
7573694 7595861	ØF-10.5 A-63 C-134 L-80

APOIO ANTERIOR DO MOTOR	
	UNO Gas. exepcto CS UNO R/89 1.5 até mot. 7957553
4520049	
5974777	ØF-12 A-57 C-131.5 L-80

APOIO LATERAL DO MOTOR	
	UNO D UNO TD UNO R/89 994 UNO R/89 1116 UNO R/89 1370 UNO R/89 1500
4520053	
7622921	ØFr-8 A-77.5 L-91



APOIO ANTERIOR DO MOTOR	
	DUCATO D após viatura 0198096 NOVA DUCATO após 6/87 TALENTO
4520065	
7550024 7601889	ØF-10.5 ØP-12 A _P -31 A-79

APOIO POSTERIOR DO MOTOR	
	NOVA DUCATO R/90 Gas. NOVA DUCATO R/90 1.9D NOVA DUCATO R/90 1.9TD NOVA DUCATO R/90 2.0 75cv NOVA DUCATO R/90 2.0 85cv TALENTO
4520066	
5934176	ØP-12 A _P -26 ØF-10.5 A-88.5 C-149 L-57

APOIO ANTERIOR DO MOTOR	
	PANDA R/86 1.3D
4520067	
7583543	ØP-10 A _P -50.5

APOIO ANTERIOR DO MOTOR	
	UNO 1697 D UNO R/89 1697 D - 1930 D - TD
4520097	
7589520	ØF-2x11 ØP-10 A _P -35

APOIO DE MOTOR LADO DA CAIXA DE VELOCIDADES - Após viatura 0341865	
	NOVA DUCATO R/90 2.5D NOVA DUCATO R/90 2.5TD
4520098	
7599694	ØF-2x11 ØP-12 A _P -25 A-102 C-148 L-57.5

APOIO SUPERIOR DIREITO DO AMORTECEDOR DA SUSPENSÃO ANTERIOR	
	BRAVO/BRAVA 1.4 - 1.6 até 12/95 BRAVO/BRAVA 2.0 HGT até 12/95 BRAVO/BRAVA '98 1.6 BRASILE BARAVO/BRAVA 2.0 HGT COUPÉ TEMPRA
4520099	
60811372 7639243 46414183 7683363	ØF-12 ØF _R -3xM7

APOIO SUPERIOR ESQUERDO DO AMORTECEDOR DA SUSPENSÃO ANTERIOR	
	TEMPRA TIPO DX 1.1-1.4-1.6-1.9D TIPO SX 1.1-1.4-1.6 c/ D.A. TIPO SX 1.8-1.8 16V Sport- 2.0 TIPO SX 2.0 16V Sport- 1.7D TIPO SX 1.9TD após viatura 4206178
4520099	
60811372 7639243 46414183 7683363	ØF-12 ØF _R -3xM7

APOIO DE MOTOR LADO DA CAIXA DE VELOCIDADES	
	UNO 1607 D - TD UNO R/89 1697 D - 1930 D
4520100	
7571214	ØF-3x6 ØF _R -10 A-62 C-105 L-90.5



SUPORTE SUPERIOR DO AMORTECEDOR ANTERIOR	
	PUNTO 55 - 60 - 75 - 90 PUNTO GT - CABRIO PUNTO '97 exepcto CABRIO
4520101	
7775940	ØF-12 ØFR-2x10 A-50

SUPORTE ANTERIOR DO MOTOR	
	UNO R/89 994 - 1116 UNO R/89 1300 D - TD
4520102	
5988148	ØF-2x11 ØF-2x12 ØFR-12 A-71 C-135 L-84.5

APOIO ANTERIOR DO MOTOR LADO DA DISTRIBUIÇÃO	
	TEMPRA 1.4 - 1.6 TIPO 1.1 - 1.4 - 1.6
4520103	
7610541	ØF-10.5 A-73.5 C-164

SUPORTE DIREITO DO MOTOR LADO DA CAIXA DE VELOCIDADES	
	PUNTO 55 - 55 6 Velocidades PUNTO 60 - 60 CABRIO PUNTO 75 PUNTO '97 55 - 60 - 60 CABRIO PUNTO '97 75 - 90 PUNTO '97 1.7D
4520104	
7765891	ØP-10 A _p -71

SUPORTE LATERAL DO MOTOR	
	UNO 45 - 50 - 60 - 70 UNO R/89 900 - 1000 - 1100
4520105	
5937315	ØF-2x16 ØFR-8 A-41 C-147 L-75

SUPORTE ANTERIOR DO MOTOR	
	PUNTO exepcto 55 6 velocidades
4520106	
	ØF-10 ØF-2x9.5 ØF-2x4 A-57.5 C-133.5 L-80

SUPORTE POSTERIOR DO MOTOR	
	PANDA R/86 PANDA 4x4 Maq. 91
4520107	
7544643	ØF-8.5 ØF-2x16 A-64.5 C-131 L-80

SUPORTE INTERMÉDIO DO MOTOR	
	PUNTO GT PUNTO 1.7TD PUNTO '97 GT PUNTO '97 1.7D
4520112	
7765892	ØP-10 A _p -70



APOIO ESQUERDO DO MOTOR LADO DA CAIXA DE VELOCIDADES	
	PUNTO 55 - 55 6 Velocidades PUNTO 60 - 75 - 60 Cabrio PUNTO '97 90 PUNTO '97 Cabrio 60 - 90
4520113	
7784313	ØF-18 ØF-3x16 ØFr-10 A-82

SUPORTE DE MOTOR LADO DA DISTRIBUIÇÃO	
	TIPO 1.1
4520114	
7594993	ØF-10.5 ØF-2x8.5 A-67 C-135 L-80

SUPORTE DO MOTOR LADO DA DISTRIBUIÇÃO	
	REGATA 100S RITMO 105 TC RITMO 125 TC NOVO RITMO 105 TC NOVO RITMO 130 TC
4525003	
SE831154205A	ØF-12.5 A-58 C-135 L-85

SUPORTE POSTERIOR DO MOTOR	
	RITMO 105 TC RITMO 125 TC RITMO 130 TC RITMO D NOVO RITMO D
4525006	
5920938	ØF-12 ØF-2x16 A-65 C-133.5 L-80

SUPORTE ANTERIOR DO MOTOR VIATURAS COM VELOCIDADES AUTO.	
	REGATA 70 - 80 REGATA R/86 70 - 85
4525007	
4433963	ØF-16\12 ØF-2x16 A-47.5 C-133.5 L-80.5

SUPORTE ANTERIOR DO MOTOR	
	RITMO 1ª Série RITMO FL85 60 - 70 - 85 NOVO RITMO 60 - 70 - 85
4525007	
4433963	ØF-16\12 ØF-2x16 A-47.5 C-133.5 L-80.5

SUPORTE DE MOTOR LADO DA CAIXA DE VELOCIDADES	
	REGATA 70 - 85 RITMO 1ª Série RITMO FL85 60 - 70 - 85 NOVO RITMO 60 - 70 - 85
4525008	
4433964	ØF-12 ØF-2x16 A-49 C-133 L-80

APOIO POSTERIOR DO MOTOR	
	NOVA DUCATO R/90 TALENTO R/90
4580057	
7663999 7755436	ØF-14.5 ØF-2x10.5 ØFr-2x10 A-111 L-73.5

BATENTE CENTRAL DA BARRA ESTABILIZADORA ANTERIOR	
	UNO após 3/87 e exepto CS
4520074	
7603476	ØF-17.5 ØP-2x8 A _P -2x18.5 A-34 C-66 L-34

BATENTE DA BARRA ESTABILIZADORA ANTERIOR	
	NOVA DUCATO R/90 D TALENTO
4520108	
4339248	ØE-48 ØF-22 A-25

BATENTE DA BARRA ESTABILIZADORA ANTERIOR	
	BRAVO/BRAVA BRAVO/BRAVA '98 COUPÉ CROMA após 1/92 TEMPRA TIPO
4520109	
7601642	ØE-31 ØF-10 A-19

CASQUILHO SUPERIOR DO AMORTECEDOR DA SUSPENSÃO POSTERIOR	
	127 D - RUSTICA - PANORAMA NOVO 127 1050 Gas. - 1300D PANORAMA 128 após viatura 051766 REGATA até viatura 7073265 RITMO 1ª Série NOVO RITMO
4520044	
4223535 4227114	ØE-41.7 ØF-12 A-18

CASQUILHO SUPERIOR E INFERIOR DO AMORTECEDOR DA SUSPENSÃO POSTERIOR	
	FIORINO 1ª Série
4520044	
4223535 4227114	ØE-41.7 ØF-12 A-18

CASQUILHO DA EXTREMIDADE DA CREMALHEIRA DA DIRECÇÃO	
	126 após 1/5/78 127 128 DUNA até 6/87 PANDA R/86 PANDA Maq. 91 4x4 1.0 - 1.1 REGATA até 6/87
4525013	
4330731 4179805	ØF-20.5 A-18.5 C-28 L-28

CASQUILHO DA EXTREMIDADE DA CREMALHEIRA DA DIRECÇÃO	
	RITMO até 6/87 UNO 1ª Série até 6/85 UNO D até 5/87 UNO TURBO FIORINO 1ª Série NOVA FIORINO
4525013	
4330731 4179805	ØF-20.5 A-18.5 C-28 L-28

CASQUILHO DO BRAÇO DE SUSPENSÃO ANTERIOR	
	125 132 ARGENTA REGATA 100S 105cv NOVO RITMO 105TC NOVO RITMO 130TC
4525014	
4125492	ØE-55 ØF-23 A-32

CASQUILHO DO BRAÇO DE SUSPENSÃO ANTERIOR	
	125 132 ARGENTA REGATA 100S 105cv NOVO RITMO 105TC NOVO RITMO 130TC
4525018	
4125489	ØE-55 ØF-23 A-26

CAPA DE PEDAL DA EMBRAIAGEM	
	131 L - CL SUPERMIRAFIORI SUPERMIRAFIORI D
4520011	
4395061	C-101 L-50

CAPA DE PEDAL DO TRAVÃO	
	131 L - CL SUPERMIRAFIORI SUPERMIRAFIORI D
4520012	
4395064	C-101 L-50

CAPA DE PEDAL DO ACELERADOR	
	127 128 RITMO FIORINO 1ª Série
4520013	
4187379 SE021110044A	C-96.5 L-43.5

CAPA DE PEDAL DO TRAVÃO E EMBRAIAGEM	
	124-125-127-128 850-900-1100 PANDA R/86 PANDA Maq. '91 RITMO após 7/79
4520014	
4144275	C-64.5 L-50

CAPA DE PEDAL DO TRAVÃO E EMBRAIAGEM	
	DUCATO R/94 NOVA DUCATO R/90 FIORINO 1ª Série TALENTO
4520014	
4144275	C-64.5 L-50

CAPA DE PEDAL DO TRAVÃO E EMBRAIAGEM	
	124 - 125 - 127 - 850 - 900 1100 PANDA R/86 PANDA Maq. '91 4x4 RITMO após 7/79 RITMO D após 7/79 RITMO S após 7/79
4520056	
4144275	C-64 L-50.5

CAPA DE PEDAL DO TRAVÃO E EMBRAIAGEM	
	DUCATO R/90 NOVA DUCATO R/90 FIORINO 1ª Série TALENTO
4520056	
4144275	C-64.5 L-51



CAPA DE PEDAL DO TRAVÃO E EMBRAIAGEM	
	125 131 131S 132 ARGENTA BARCHETTA BRAVO/BRAVA BRAVO/BRAVA '98 DUNA MULTIPLA
4525010	
4170605 7568442	A-10 C-79.5 L-48

CAPA DE PEDAL DO TRAVÃO E EMBRAIAGEM	
	PALIO WEEKEND EUROPA PUNTO PUNTO '97 NOVO PUNTO RITMO TEMPRA TIPO
4525010	
4170605 7568442	A-10 C-79.5 L-48

CAPA DE PEDAL DO TRAVÃO E EMBRAIAGEM	
	UNO FIORINO R/93 NOVO FIORINO
4525010	
4170605 7568442	A-10 C-79.5 L-48

KIT DA CAIXA DE VELOCIDADES	
	UNO
4520010	5x-Grampos 4x-ØE-12.6 ØF-10 A-9.7 2x-ØE-16 ØF-14 A-20.7 2x-ØE-16.9 ØF-10 A-16 1x-ØE-10 ØP-M6 A-43 1x-Porca M6 1x-ØE-20.6 ØF-7.9 A-1.7 1x-ØE-20.1 ØF-12.7 A-0.5

KIT DA CAIXA DE VELOCIDADES	
	UNO 900 - 1100 - 1300D
4520015	3x-Grampos 4x-ØE-12.5 ØF-10 A-10 2x-ØE-17 ØF-10 A-16 1x-ØE-16.5 ØF-8 A-7 1x-ØE-20.5 ØF-8 A-1.5

TAMPA DA VARETA DO ÓLEO	
	124-125-127-128-131-132 238-224-241 600-850-900-1100 AREGNTA CINQUECENTO excepto 704 CROMA MAREA '98 1.2 16V PANDA 4x4 '91 750-950
4520045	ØE-17 A-42
4102056 4328493	

TAMPA DA VARETA DO ÓLEO	
	PUNTO Gas. PUNTO '97 55 - 60 - 75 NOVO PUNTO 60 - 80 REGATA 70 - 85 REGATA excepto tipo S RITMO
4520045	
4102056 4328493	ØE-17 A-42

TAMPA DA VARETA DO ÓLEO	
	SEICENTO 1100 SPI SUITE SEICENTO 1100 SPI SPORTING TEMPRA 1.4 - 1.4 Maq. após 93 TEMPRA 1.6 - 1.6 Maq. após 93 TIPO 1.1 TIPO 1.4 - 1.4 Maq. TIPO 1.6 - 1.6 Maq.
4520045	
4102056 4328493	ØE-17 A-42

TAMPA DA VARETA DO ÓLEO	
	UNO 1ª Série UNO R/89 900 - 1000 - 1100 UNO R/89 1500 UNO R/89 TURBO 1300 - 1370 FIORINO 1ª Série NOVA FIORINO 1.5 FIORINO R/93 1.4 - 1.6
4520045	
4102056 4328493	ØE-17 A-42

BOTÃO DE CAPOT	
	124 128 após 1/9/71 131 1ª Série 132 PANDA R/86 1.30 PANDA Maq. 91 4x4 REGATA
4525011	
4276430	ØE-17 A-43

BOTÃO DE CAPOT	
	RITMO UNO 1ª Série
4525011	
4276430	ØE-17 A-43

TIRANTE DE FIXAÇÃO DA CHAPELAEIRA	
	127
4525012	
	C-331

SUPORTE DO TUBO DE ESCAPE	
	COUPÉ PANDA 1.0 R/86 PANDA 4x4 R/86 PANDA 1.0 4x4 MQ 91 PANDA 1.1 4x4 MQ 91 RITMO FL/85 TD TIPO 1370 - TIPO 1580 TEMPRA
4520016	
5989798	C-59.8 L-44.2

ESTICADOR DE ESCAPE	
	CINQUECENTO PANDA R/86 700-900-1.0-1.1 PANDA 4x4 MAQ '91 SEICENTO TEMPRA 1ª Série TIPO 1ª Série
4520030	
7600807	A-42 C-67.5 L-44.5

ESTICADOR POSTERIOR DO ESCAPE	
	PUNTO PUNTO '97 NOVO PUNTO 60 NOVO PUNTO 80
4520031	
7718578	A-25.5 C-95 L-36

ESTICADOR POSTERIOR DO ESCAPE	
	UNO exepito CS
4520050	
7612390	A-59 C-71 L-44.5

ESTICADOR DE ESCAPE	
	124 - 127 Gas - 128 238 - 242 PANDA 30 - 40 - 4x4 1ª Série DUCATO até 2/82 FIORINO 1ª Série
4520051	
4296059 4312280	∅F-6.5 A-33.5 C-79.5 L-36

SUPORTE DO TUBO DE ESCAPE	
	TEMPRA TIPO
4520075	
7637572	A-14.5 C-59 L-34

SUPORTE POSTERIOR DO TUBO DE ESCAPE	
	TEMPRA 1.4 - 1.6 - 1.8 - 2.0 TEMPRA 1.9D TIPO
4520076	
7698769	A-44 C-68.5 L-44.5

SUPORTE DO TUBO DE ESCAPE	
	BARCETTA BRAVO/BRAVA BARVO/BRAVA '98 COUPÉ 1ª Série COUPÉ 1.8 16V ASP COUPÉ 2.0 20V ASP COUPÉ 2.0 20V ASP STEP-A
4520096	
7740653 46421002	∅F-2x8 A-26 C-55 L-38

SUPORTE DO TUBO DE ESCAPE	
	MAREA MAREA '98 PUNTO PUNTO '97 exepito 90 CABRIO SEICENTO exepito ELECTRA
4520096	
7740653 46535839 7718577 46421002	∅F-2x8 A-26 C-55 L-38

SUPORTE POSTERIOR DO TUBO DE ESCAPE	
	DUNA PANDA R/86 1.3D REGATA RITMO 1ª Série RITMO FL85 TDS TEMPRA 1.8 - 2.0 UNO exepito CS
4525005	
7508963 4387293	A-27.5 C-54 L-44

SUPORTE POSTERIOR DO TUBO DE ESCAPE	
	FIORINO R/93 NOVA FIORINO
4525005	
7508963 4387293	A-27.5 C-54 L-44

SUPORTE POSTERIOR DO TUBO DE ESCAPE	
	COUPÉ 1ª Série DUNA REGATA TIPO 1.8 TIPO 1.8 Maq. após 93 TIPO 2.0 TIPO 2.0 Maq. após 93
4530028	
5983764	∅F-4x8.5 A-31 C-87.5 L-26.5



SUPORTE POSTERIOR DO TUBO DE ESCAPE	
	UNO CS FIORINO R/93 Gas. NOVA FIORINO
4530028	
5983764	∅F-4x8.5 A-31 C-87.5 L-26.5

ANEL DE ESCAPE	
	131-132 ARGENTA COUPÉ CROMA DUNA REGATA NOVORITMO 105TC-130TC TEMPRA 1.4-1.6-1.8-2.0-1.9TD
4545023	
4422885 7610077 82409205	∅E-63 A-15

ANEL DE ESCAPE	
	TIPO expto 1.1 UNO DUCATO R/94 NOVA DUCATO R/90 FIORINO R/93 NOVA FIORINO TALENTO
4545023	
4422885 7610077 82409205 4437668	∅E-63 A-15

FOLE DO SEMI-EIXO DIFERENCIAL LADO DA CAIXA DE VELOCIDADES	
	DUCATO R/94 NOVA DUCATO R/90 TALENTO
4510032	
95569341	∅F _G -94 ∅F _P -24 A-103

FOLE DO SEMI-EIXO DIFERENCIAL LADO DA RODA	
	DUCATO R/90 NOVA DUCATO R/94 TALENTO
4510048	
95569342 95653068	∅F _G -95 ∅F _P -24 A-150

FOLE DO SEMI-EIXO DIFERENCIAL LADO DA CAIXA COM CASQUILHO DE NYLON	
	127 após 1/84 PANDA R/86 até 2/86 REGATA de 4/85 a 2/86 RITMO de 4/85 a 2/86 UNO de 12/84 até 2/86 expto TURBO IE e TD FIORINO de 1/84 a 2/86 NOVA FIORINO
4520028	
92601255	∅F _G -71 ∅F _P -23 A-73

FOLE DO SEMI-EIXO DIFERENCIAL LADO DA RODA	
	BARCETTA até 5/96 BRAVOIBRAVA 1.8 - 1.8 GT - 1.9 TD 75 CV - - 1.9 TD 100 CV - 1.9 JTD após 92 COUPÉ 1ª Série CROMA após 7/88 PUNTO GT PUNTO 1.7 TD TEMPRA ANTISKID 1.8 - 2.0 - 1.9D - 1.9TD TIPO ANTISKID 1.8 16V SPORT - 2.0 16V SPORT TIPO ANTISKID D ULYSSE 2.0 IE após 9/94
4520029	
82483504 82462961	∅F _G -92 ∅F _P -24 A-84

FOLE ESQUERDO DO SEMI-EIXO DIFERENCIAL COM CASQUILHO DE NYLON - LADO DA CAIXA	
	127 após 1/84 PANDA 1ª Série após 2/86 REGATA de 4/85 a 2/86 RITMO de 4/85 a 2/86 UNO de 12/84 a 2/86 UNO expto TURBO IE e TD FIORINO de 1/84 a 2/86 NOVA FIORINO de 1/84 a 2/86
4520036	
	∅F _G -72 ∅F _P -25 A-72



FOLE DO SEMI-EIXO DIFERENCIAL LADO DA RODA	
	DUCATO R/90 DUCATO R/94 TALENTO
4520037	
95569342 95653068	∅F _G -92 ∅F _P -24 A-145

FOLE DO SEMI-EIXO DIFERENCIAL LADO DA RODA	
	127 900-1050 após 8/86 PANDA R/86 de 1/84 até 2/89 REGATA 1ª Série REGATA R/86 70-85-100-D RITMO FL85 RITMO FL D NOVO RITMO
4520038	
5987092	∅F _G -68 ∅F _P -20 A-80

FOLE DO SEMI-EIXO DIFERENCIAL LADO DA RODA	
	UNO exep ^{to} TURBO IE-CS até 9/87 UNO TD até viat. 2831935 FIORINO 1ª Série
4520038	
5987092	∅F _G -68 ∅F _P -20 A-80

FOLE CENTRAL DO AMORTECEDOR DA SUSPENSÃO ANTERIOR	
	BRAVO/BRAVA 1.4 até 12/95 BRAVO/BRAVA 1.6 até 12/95 TIPO 1.1-1.4-1.6 TIPO 1.7D-1.9D TEMPRA 1.4-1.6 TEMPRA D
4520039	
7607086	∅F _G -61 ∅F _P -16 A-196

FOLE DIREITO DA DIRECÇÃO	
	126 após 5/78 127 128 após 8/75 DUNA PANDA 30-45 REGATA sem D.A. RITMO - RITMO FI45 100S-TDS NOVO RITMO
4520040	
4239459 4371156	∅F _G -26 ∅F _P -10 A-165

FOLE DIREITO DA DIRECÇÃO	
	UNO 1ª Série até 5/87 FIORINO - FIORINO R/93 NOVA FIORINO
4520040	
4239459 4371156	∅F _G -26 ∅F _P -10 A-165

FOLE DO SEMI-EIXO DIFERENCIAL LADO DA CAIXA DE VELOCIDADES	
	BRAVO/BRAVA 1.4 após 9/95 CINQUECENTO 1108 SPI PUNTO 55 - 60 - 6 Velocidades PUNTO CABRIO PUNTO '97 55 - 60 PUNTO '97 CABRIO
4520041	
7746232	∅F _G -60 ∅F _P -19 A-90

FOLE DO SEMI-EIXO DIFERENCIAL LADO DA CAIXA DE VELOCIDADES	
	SIECENTO 1.1 SPI SUITE SEICENTO 1.1 SPI SPORTING UNO R/89 900 após 1/93 UNO R/89 1000 após 1/93 UNO R/89 1100 após 1/93
4520041	
7746232	∅F _G -60 ∅F _P -19 A-90



FOLE DO SEMI-EIXO DIFERENCIAL LADO DA CAIXA DE VEL.	
	127 de 10/82 a 12/83 127 D após 1/84 DUNA REGATA até 3/85 FIORINO de 10/82 a 10/91 FIORINO 1ª Série NOVA FIORINO
4520046	
92601216 92601171	∅F _G -64 ∅F _P -23 A-73

FOLE ESQUERDO DO SEMI-EIXO DIFERENCIAL LADO DA CAIXA DE VEL.	
	PANDA R/86 até 9/87
4520046	
92601216 92601171	∅F _G -64 ∅F _P -23 A-73

FOLE DIREITO DO SEMI-EIXO DIFERENCIAL LADO DA CAIXA DE VEL.	
	REGATA após 4/85 RITMO de 4/85 a 9/87
4520046	
92601216 92601171	∅F _G -64 ∅F _P -23 A-73

FOLE DO SEMI-EIXO DIFERENCIAL LADO DA CAIXA DE VELOCIDADES	
	BRAVO/BRAVA 1.9D CINQUECENTO 899 - 903 CINQUECENTO SPI 899 - 903 PANDA R/86 PANDA Maq. '91 4x4 REGATA após 10/87 REGATA exepcto TD e vel. Auto.
4520054	
7625541	∅F _G -80 ∅F _P -30 A-82

FOLE DO SEMI-EIXO DIFERENCIAL LADO DA CAIXA DE VELOCIDADES	
	RITMO F185 após 10/87 TEMPRA 1.4 - 1.6 - 1.9D TIPO 1.1 - 1.4 - 1.6 - 1.7D - 1.9D UNO de 10/87 a 12/92 UNO exepcto TURBO e CS FIORINO 1ª Série FIORINO R/93 1.4 - 1.6 - D
4520054	
7625541	∅F _G -80 ∅F _P -30 A-82

FOLE DO AMORTECEDOR ANTERIOR	
	PUNTO PUNTO '97
4520059	
7762158 7757917	∅F _G -60 ∅F _P -18 A-200

FOLE SUPERIOR DO AMORTECEDOR ANTERIOR	
	PANDA R/86 1.3D PANDA Maq. '91 4x4
4520061	
4409263	∅F _G -60 ∅F _P -20 A-182

FOLE ESQUERDO DA DIRECÇÃO	
	126 após 5/78 127 - 128 DUNA PANDA 1ª Série após 9/87 REGATA R/86 75 - 80 - 100 REGATA R/86 100 - DS - TDS UNO até 5/87
4520063	
4239458 4371155	∅F _G -42 ∅F _P -10 A-125



FOLE ESQUERDO DA DIRECÇÃO	
	FIORINO FOIRINO R/93 NOVA FIORINO
4520063	
4239458 4371155	∅F _G -42 ∅F _P -10 A-125

FOLE ESQUERDO DA DIRECÇÃO ASSISTIDA	
	REGATA 100S - D - WEEK RITMO RITMO FL85 100S - TDS NOVO RITMO
4520063	
4239458 4371155	∅F _G -42 ∅F _P -10 A-125

FOLE ESQUERDO E DIREITO DA DIRECÇÃO ASSISTIDA	
	REGATA DS REGATA R/86 100 REGATA R/86 DS REGATA R/86 TDS
4520063	
4239458 4371155	∅F _G -42 ∅F _P -10 A-125

FOLE DO SEMI-EIXO DIFERENCIAL LADO DA RODA	
	126 127 SPECIAL até 10/77 128 1ª Série DUNA
4520068	
4215015	∅F _G -70 ∅F _P -20 A-100

FOLE DO SEMI-EIXO DIFERENCIAL LADO DA RODA	
	CINQUECENTO PANDA R/86 PANDA 4x4 Maq. 91 SEICENTO excepto ELETTRA TEMPRA 1.4 - 1.6 - 1.9D - 1.9TD TIPO após 7/90 1.1 - 1.4 - 1.6 - D UNO após 10/87 e excepto TURBO IE e CS
4520071	
7682886	∅F _G -65 ∅F _P -19.5 A-81

FOLE ESQUERDO DO SEMI-EIXO DIFERENCIAL LADO DA CAIXA DE VELOCIDADES	
	PANDA R/84 PANDA 4x4 Maq. 91 REGATA exceptp TDS RITMO UNO excepto TURBO IE e TD FIORINO 1ª Série NOVA FIOIRINO
4520072	
92601366	∅F _G -79 ∅F _P -23 A-75

FOLE ESQUERDO DA DIRAECÇÃO	
	NOVA DUCATO R/90 TALENTO
4520073	
9750000280	∅F _G -49 ∅F _P -11 A-155

FOLE DO SEMI-EIXO DIFERENCIAL LADO DA RODA - ATÉ 7/90	
	TEMPRA 1.4 TEMPRA 1.6 TEMPRA 1.9D TIPO 1.1 TIPO 1.4 TIPO 1.6 TIPO D
4520079	
7635255	∅F _G -75 ∅F _P -20 A-104



FOLE DO AMORTECEDOR ANTERIOR	
	NOVA DUCATO R/90 Gas. NOVA DUCATO 1.9D NOVA DUCATO 2.5D NOVA DUCATO 2.5TD
4520080	
5947829 7562093	ØF _G -104 ØF _P -36.5 A-185

FOLE DIREITO DA DIRECÇÃO	
	NOVA DUCATO R/90 TALENTO
4520081	
9750000380	ØF _G -38 ØF _P -11.5 A-215

FOLE DIREITO E ESQUERDO DA DIRECÇÃO	
	TEMPRA TIPO
4520082	
7566840	ØF _G -44 ØF _P -10 A-155

FOLE DO SEMI-EIXO DIFERENCIAL LADO DA RODA	
	BRAVO/BRAVA 1.4 - 1.6 - 1.9D BRAVO/BRAVA '98 1.2 - 1.6 BRAVO/BRAVA '98 1.6 vel. auto. MAREA 1.4 12V 80cv MAREA '99 1.2 16V PALIO WEEKEND EUROPA 1.2 PUNTO - PUNTO '97
4520083	
7761570	ØF _G -78 ØF _P -22 A-81

FOLE ESQUERDO E DIREITO DA DIRECÇÃO	
	TEMPRA TIPO
4520084	
	ØF _G -45 ØF _P -10 A-160

FOLE DO SEMI-EIXO DIFERENCIAL LADO DA CAIXA DE VELOCIDADES	
	CINQUECENTO 899 - 899 SPI CINQUECENTO 903 - 903 SPI PANDA R/86 PANDA 4x4 Maq. 91 REGATA após 10/87 e exepto TD RITMO FL85 após 10/87
4520085	
7621245	ØF _G -74 ØF _P -30 A-85

FOLE DO SEMI-EIXO DIFERENCIAL LADO DA CAIXA DE VELOCIDADES	
	UNO R/89 1100 - 1116 UNO R/89 1300D FIORINO 1ª Série
4520085	
7621245	ØF _G -74 ØF _P -30 A-85

FOLE ESQUERDO E DIREITO DA DIRECÇÃO SEM DIRECÇÃO ASSISTIDA	
	PUNTO exepto 1.7D - 1.7TD PUNTO '97 exepto 1.7D - 1.7TD TEMPRA TIPO 1.1 - 1.4 - 1.6 - D TIPO após viatura 0039761
4520086	
7645160	ØF _G -55 ØF _P -10.5 A-214



KIT FOLE DO SEMI-EIXO DIFERENCIAL LADO DA CAIXA DE VELOCIDADES - EIXO 23mm	
	BRAVO/BRAVA 1.9 D CINQUECENTO 899 - 899 SPI CINQUECENTO 903 - 903 SPI PANDA 1ª Série após 10/87 REGATA após 10/87 exopto TD e caixa automática RITMO FL85 após 10/87
4520087	$\varnothing F_G-30 \varnothing F_P-80$ A-82

KIT FOLE DO SEMI-EIXO DIFERENCIAL LADO DA CAIXA DE VELOCIDADES - EIXO 23mm	
	FIORINO 1ª Série só esquerdo FIORINO R/93 após viat. 8475116 FIORINO R/93 1.4 - 1.6 - D
4520087	$\varnothing F_G-30 \varnothing F_P-80$ A-82

KIT FOLE DO SEMI-EIXO DIFERENCIAL LADO DA CAIXA DE VELOCIDADES - EIXO 23mm	
	CINQUECENTO 899 - 899 SPI CINQUECENTO 903 - 903 SPI PANDA 1ª Série após 10/87 REGATA após 10/87 REGATA exopto TD e caixa auto. RITMO FL85 - FL85 D após 10/87
4520088	$\varnothing F_G-74 \varnothing F_P-30.5$ A-86

KIT FOLE DO SEMI-EIXO DIFERENCIAL LADO DA CAIXA DE VELOCIDADES - EIXO 23mm	
	UNO de 10/87 a 12/92 UNO R/89 1100 - 1116 - 1300D FIORINO 1ª Série após 10/87
4520088	$\varnothing F_G-74 \varnothing F_P-30.5$ A-86

FOLE CENTRAL DO AMORTECEDOR ANTERIOR	
	REGATA UNO exopto CS
4520122	$\varnothing F_G-58 \varnothing F_P-18$ A-190
5978771	

FOLE DO SEMI-EIXO DIFERENCIAL LADO DA CAIXA DE VELOCIDADES	
	127 128 PANDA 45 RITMO 1ª Série FIORINO
4520127	$\varnothing F_G-64 \varnothing F_P-25$ A-85
4333088	

FOLE DO SEMI-EIXO DIFERENCIAL LADO DA CAIXA DE VELOCIDADES	
	BARCHETTA até 5/96 BRAVO/BRAVA 1.8 - 1.8 GT BRAVO/BRAVA 2.0 HGT BRAVO/BRAVA '98 1.8 - 1.8 GT BRAVO/BRAVA '98 2.0 HGT COUPÉ CROMA após 11/88
4565004	$\varnothing F_G-51 \varnothing F_P-22$ A-81
82282140	

FOLE DO SEMI-EIXO DIFERENCIAL LADO DA CAIXA DE VELOCIDADES	
	MAREA 1.8 - 2.0 MAREA '99 1.8 16V - 2.0 16V MULTIPLA 1.9 JTD PUNTO GT TURBO-1.7 D-1.7 TD PUNTO '97 GT TURBO-1.7 TD NOVO PUNTO 130 - 1.9 JTD RITMO 125 TC 1ª Série
4565004	$\varnothing F_G-51 \varnothing F_P-22$ A-81
82282140	



FOLE DO SEMI-EIXO DIFERENCIAL LADO DA CAIXA DE VELOCIDADES	
	TEMPRA TIPO UNO TURBO IE UNO R/86 TURBO IE
4565004	
82282140	ØF _G -51 ØF _P -22 A-81

JOGO DE PALAS FIAT UNO	
	
4520130	
	C-375 L-211

JOGO DE PALAS LINEACESSORI	
	
4520130.1	
	C-370 L-205

SILENT-BLOC DO APOIO 4510008	
	NOVA DUCATO R/90 TALENTO
4510009	
	ØE-70 ØF-12 A _E -50 A-64

SILENT-BLOC DO TRIÂNGULO DA SUSPENSÃO TRASEIRA (CURTO)	
	
4520005	
	ØE-27.5 ØE _A -38 ØF-13 A-32.5

SILENT-BLOC DO TRIÂNGULO DA SUSPENSÃO TRASEIRA (LONGO)	
	
4520006	
	ØE-27.5 ØE _A -38 ØF-13 A-37.5

SILENT-BLOC INFERIOR DA SUSPENSÃO TRASEIRA	
	
4520007	
	ØE-32.5 ØE _A -44 ØF-16.5 A-45

SILENT-BLOC SUPERIOR DA SUSPENSÃO TRASEIRA	
	124
4520008	
	ØE-31 ØE _A -40.5 ØF-14 A-38



SILENT-BLOC DA SUSPENSÃO TRASEIRA	
	PUNTO
4520021	
7756218	ØE-60 ØEA-73 ØF-15 A-47.5

SILENT-BLOC DA SUSPENSÃO TRASEIRA	
	PUNTO
4520022	
7755671	ØE-50.5 ØEA-66 ØF-16 A-38.5

BATENTE SUPERIOR DO AMORTECEDOR DA SUSPENSÃO ANTERIOR	
	UNO exepcto CS
4520033	
5968311 7559908 7567590	ØE-65 ØF-12.2 A-44

SILENT-BLOC DIREITO DO BRAÇO DE SUSPENSÃO DIREITO	
	PUNTO PUNTO '97
4520034	
7775344	ØF-18.9 A-53 C-103 L-59

BATENTE DA BARRA ESTABILIZADORA ANTERIOR	
	BRAVO/BRAVA exepcto 1.4-1.6 BRAVO/BRAVA '98 exepcto 1.2-1.6 COUPÉ '96 TEMPRA TIPO 1.1 após 3/88 TIPO 1.1 até viatura 2502050
4520042	
7635711	ØF-20 A-47 C-59.5 L-48

SILENT-BLOC ANTERIOR DO BRAÇO DE SUSPENSÃO	
	CINQUECENTO UNO exepcto CS
4520043	
5927292	ØE-32 ØEA-37.5 ØF-12.1 A-54.75

SILENT-BLOC CENTRAL DO BRAÇO DE SUSPENSÃO	
	PUNTO PUNTO '97
4520043	
5927292	ØE-32 ØEA-37.5 ØF-12.1 A-54.75

SILENT-BLOC ANTERIOR DO BRAÇO DE SUSPENSÃO ANTERIOR	
	BRAVO/BRAVA BRAVO/BRAVA '98 COUPÉ TEMPRA TIPO
4520052	
7601064	ØF-20 ØFR-9 L-49.5

SILENT-BLOC POSTERIOR DO BRAÇO DE SUSPENSÃO	
	CINQUECENTO UNO exepcto CS
4520057	
5927293	∅F _P -5.5 C-57.5 L-49.5

SILENT-BLOC POSTERIOR DO BRAÇO DIREITO DA SUSPENSÃO ANTERIOR	
	BRAVO/BRAVA BRAVO/BRAVA '98 COUPÉ TEMPRA TIPO
4520058	
7601068	∅F-19.9 ∅F _R -10 L-52

SILENT-BLOC CENTRAL DA BARRA ESTABILIZADORA ANTERIOR	
	TEMPRA TIPO após 2/88 TIPO exepcto 1.1
4520060	
7601646	∅F-23 A-47.5 C-41 L-60

SILENT-BLOC ESQUERDO DO BRAÇO DE SUSPENSÃO ESQUERDO	
	PUNTO PUNTO '97
4520062	
7775343	∅F-18.8 L-59

SILENT-BLOC POSTERIOR DO BRAÇO DE SUSPENSÃO ANTERIOR ESQUERDA	
	BRAVO/BRAVA BRAVO/BRAVA '98 COUPÉ TEMPRA TIPO
4520064	
7601065	∅F-19.8 ∅F _R -10 A-60 L-52.5

SILENT-BLOC DE MOLAS	
	DUCATO
4520133	
	∅E-38 ∅F-16 A _E -64.5 A _I -72

SILENT-BLOC DO BRAÇO DE SUSPENSÃO POSTERIOR	
	REGATA RITMO 105TS RITMO 125TC RITMO SUPER 75 - 85
4525019	
4386632	∅E-30 ∅E _A -40.5 ∅F-13 A-43

TUBO INFERIOR DE SAÍDA DE ÁGUA DO RADIADOR	
	UNO 1697 D UNO 1697 TD
4520055	
7570384	∅F-34



TUBO DO AQUECIMENTO COM VÁLVULA	
	PUNTO 55 - 60 PUNTO 60 c/ ar condicionado PUNTO 60 SELECTA PUNTO '97 55 - 60 PUNTO '97 60 SELECTA PUNTO '97 60 CABRIO
4520069	
46417275 7755054	ØF-14 ØF-7

TUBO DE LIGAÇÃO AO FILTRO DE AR	
	REGATA 70 - 70S - ES - 85S REGATA R/86 70 - 85S REGATA R/86 70 até mot. 5974941 REGATA R/86 85 até mot. 6086844 RITMO FL85 60 - 70 - 85 RITMO FL85 60 e 70 até mot. 5974941 RITMO FL85 85 até mot. 6114921 NOVO RITMO 60 - ES NOVO RITMO SUPER 70 - 85
4520089	
5970714	ØF-20 ØF-20

TUBO DE LIGAÇÃO AO FILTRO DE AR	
	UNO 55 - 55S - 70S
4520089	
5970714	ØF-20 ØF-20

TUBO INFERIOR DE SAÍDA DE ÁGUA DO RADIADOR	
	PUNTO 1.7D - 1.7TD PUNTO '97 1.7D - 1.7TD
4520090	
46417779 7730815	ØF-32 ØF-32

TUBO SUPERIOR DE ENTRADA DE ÁGUA DO RADIADOR	
	PUNTO 55 - 55S - 55SX - 55ED PUNTO 60 CABRIO PUNTO '97 55S - 55SX PUNTO '97 55 6 Velocidades PUNTO '97 60S - 60SX PUNTO '97 75 - 90 PUNTO '97 CABRIO 60 - 90
4520091	
7718664 7770566 7745853 46441019	ØF-26 ØF-26

TUBO SUPERIOR DE ENTRADA DE ÁGUA DO RADIADOR	
	UNO IE UNO R/89 1000 FIRE UNO R/89 1100 FIRE
4520092	
7559884	ØFg-33 ØFp-27

TUBO SUPERIOR DE ENTRADA DE ÁGUA DO RADIADOR	
	UNO 1697D - TD UNO R/89 1697D - 1930D UNO R/89 1347TD UNO 60 SX
4520093	
7570385	ØF-35 ØF-35

TUBO INFERIOR DO RADIADOR VIATURAS COM AR CONDICIONADO	
	COUPÉ COUPÉ '96 2.0 20V ASP COUPÉ '96 2.0 20V ASP STEP-A COUPÉ '96 2.0 20V TURBO
4520094	
7797503	ØF-28 ØF-25 ØF-13.5 ØF-7



TUBO INFERIOR DE SAÍDA DE ÁGUA DO RADIADOR	
	PUNTO 55 - 60 - 75 PUNTO CABRIO 60 PUNTO '97 55 S - 55 SX PUNTO '97 60 S - 60 SX PUNTO '97 60 SELECTA PUNTO '97 CABRIO 60
4520094	
7797503 7773449 7722856 7780969 7770567 7772356	ØF-28 ØF-25 ØF-13.5 ØF-7

TUBO INFERIOR DE SAÍDA DE ÁGUA DO RADIADOR	
	UNO 45 - 45 S UNO R/89 45 900
4520119	
5953050	ØF-35 ØF-35

TUBO SUPERIOR DE ENTRADA DE ÁGUA DO RADIADOR	
	FIORINO 900
4520120	
4229720	ØF-31 ØF-31

TUBO SUPERIOR DE ENTRADA DE ÁGUA DO RADIADOR	
	TEMPRA 1.4 - 1.6 TIPO 1.1 - 1.4 - 1.6 TIPO exepcto viaturas com ar condicionado
4520121	
7609904	ØF-33 ØF-28

TUBO DE RETORNO DE ÁGUA DO AQUECIMENTO - COM VÁLVULA	
	PUNTO 1.7 - 1.7 TD PUNTO '97 1.7 - 1.7 TD
4520123	
7738728	ØF-16 ØF-16

TUBO INFERIOR DE SAÍDA DE ÁGUA DO RADIADOR	
	TEMPRA 1.4 - 1.6 TIPO 1.1 - 1.4 - 1.6 TIPO exepcto viat. com ar condicionado
4520124	
7609905	ØF-30 ØF-30

TUBO SUPERIOR DE ENTRADA DE ÁGUA DO RADIADOR	
	PUNTO 1.7 D - 1.7 TD PUNTO '97 1.7 D - 1.7 TD
4520125	
46417778 7730814	ØF-32 ØF-32

TUBO SUPERIOR DE ENTRADA DE ÁGUA DO RADIADOR	
	TIPO 1.1 - 1.4 - 1.6
4520126	
7609869	ØF-29 ØF-26



TUBO INFERIOR DE SAIDA DE ÁGUA DO RADIADOR	
	127 900 FIORINO 900
4520129	
4229719	ØF-34 ØF-34

TUBO DE LIGAÇÃO À BOMBA DE ÁGUA	
	TEMPRA 1.8 - 2.0 TIPO 1.8
4520129	
7634419	ØF-34 ØF-34

APOIO INFERIOR DO MOTOR	
	FIESTA
4570002	
6049904 6194624 77FB6038FD 89FB6038FA	ØP-10 A-40 C-71.5 L-55.5

APOIO POSTERIOR DO MOTOR	
	ESCORT de 2/82 a 1/86 ORION 1.1-1.3-1.6 de 2/82 a 1/86
4570006	
6140218	ØF _G -12 ØF _P -10 A-55 C-122 L-92

SUPORTE ANTERIOR INFERIOR DO MOTOR	
	ESCORT ORION
4570011	
	ØF _R -10 C-175

APOIO POSTERIOR ESQUERDO DO MOTOR	
	FIESTA D
4570013	
6193243	ØP-10 A _P -29 ØP-10 A _P -26 A-43.5 C-95.5 L-81.5

APOIO ANTERIOR DO MOTOR LADO DA CAIXA DE VELOCIDADES	
	FIESTA 900 de 83 a 89
4570014	
6160228	ØF-12.5 ØP-10 A _P -22 A-63.5 L-104

BIELA ESTICADOR DO MOTOR	
	FIESTA COURIER 1.2-1.3-1.4D
4570033	
96FB-6P082A3	ØE-100 ØF-11 ØF-10.5 C-239

APOIO DE MOTOR	
	ESCORT D FIESTA D
4570042	
6172938	ØF _P -11 ØP-10 A _P -30 A-97 C-140 L-97

APOIO POSTERIOR DO MOTOR	
	TRANSIT
4570054	
6177036	ØP-2x10 ØP-2x10 A _P -2x22 A _P -2x36

APOIO ANTERIOR DIREITO DO MOTOR	
	ESCORT de 1/86 a 8/88 FIESTA 1.1 de 83 a 89 ORION de 1/86 a 8/88
4570062	
1640021 6133904 6160229 84FB6038CD	∅F _R -10 ∅P-3x10 A _P -2x26 A _P -23 C-153 L-60

SUPORTE ANTERIOR DIREITO DO MOTOR	
	ESCORT Gas. após 90 ORION Gas. após 90
4570063	
91AB6038AG 6610300 92AB6038DA 6793344	∅P-2x12/39 ∅P-2x10/27 ∅F-12.5

SUPORTE ANTERIOR DO MOTOR	
	FIESTA 900 FIESTA 1100 FIESTA 1300
4570064	
6045281	∅F-13 ∅P-10 A _P -41.5 A-74.5 C-65 L-63

BATENTE DA BARRA ESTABILIZADORA ANTERIOR	
	FIESTA após 89
4570039	
1652936	∅F-12 A-31 C-31 L-28.5

CASQUILHO DA BARRA ESTABILIZADORA POLIURETANO	
	ESCORT
4570040	
6100905	∅E-41 ∅F-17.5 A-15

BATENTE DA BARRA ESTABILIZADORA POSTERIOR	
	ESCORT FIESTA ORION
4570071	
6543416	∅F-16 A-37 C-40 L-31

BATENTE DA BARRA ESTABILIZADORA ANTERIOR	
	FIESTA após 89
4570072	
7102392	∅F-16 A-37 C-40 L-31.5

BATENTE DA BARRA ESTABILIZADORA POSTERIOR	
	FIESTA após 89
4570073	
1659591	∅F-20 A-34.5 C-32 L-28.5

SEPARADOR DE MOLAS	
	TRANSIT após 86
4570075	
	∅E-45 A-101

CASQUILHO PLÁSTICO DA EXTREMIDADE DA CREMALHEIRA DA DIRECÇÃO	
	ESCORT FIESTA ORION
4570017	
1610371	∅F-20 A-18 C-30

SILENT-BLOC DA BARRA ESTABILIZADORA ANTERIOR	
	ESCORT após 81 ORION após 81
4570018	
5021661 6107025	∅E-45.5 ∅F-16 A-20

CASQUILHO PLÁSTICO DA DIRECÇÃO	
	ESCORT FIESTA '84 ORION
4570020	
1568682	∅F-21.5 A-18.5 C-35

CASQUILHO DE MOLAS	
	TRANSIT até 82
4570029	
1521097	∅E-27.5 ∅EA-33 ∅F-15 A-42.5

CASQUILHO DE MOLAS	
	TRANSIT após 82
4570032	
	∅E-27 ∅EA-35 ∅F-12 A-41

CAPA DE PEDAL DO TRAVÃO E EMBRAIAGEM	
	ESCORT FIESTA ORION
4570016	
1526242 72EB2457BA	C-68.5 L-52

CARDAN DA TRANSMISSÃO	
	ESCORT SIERRA
4570019	
72GG4684BA	∅F-6x12 A-46.5 C-146



KIT DE AFINAÇÃO DO PEDAL DA EMBRAIAGEM	
	ESCORT até 89 FIESTA até 89 ORION até 89
4570043	
6186200	

ESTICADOR DE ESCAPE	
	ESCORT de 80 a 8/83 FIESTA FIESTA D até 8/83 ORION após 83 SCORPIO após 85 SIERRA TRANSIT
4570001	
6048886 6053849 6111692 77FB5A262CA 77FB5A262BD	A-38.5 C-70 L-46

ESTICADOR DE ESCAPE	
	ESCORT Gas. de 9/83 a 8/91 FIESTA Gas. FIESTA D após 8/83 ORIN Gas. 9/83 a 8/91 SIERRA SCORPIO após 89 TRANSIT após 88
4570031	
6120254 6136012 6122002 81AB5A262AC	A-39 C-88.5 L-62.5

ESTICADOR DE ESCAPE	
	
4570038	
	∅E-45 A-39

FOLE CENTRAL DO AMORTECEDOR ANTERIOR	
	ESCORT FIESTA desde 89 ORION
4570034	
1654205	

FOLE DO SEMI-EIXO DIFERENCIAL LADO DA RODA	
	ESCORT 1.1 após 9/80 FIESTA 0.9 - 1.1
4570036	
6028724 77TT3A331AA	∅Fg-68 ∅Fp-20 A-100

FOLE DO SEMI-EIXO DIFERENCIAL LADO DA CAIXA DE VELOCIDADES E DA RODA	
	ESCORT 1.3 - 1.6 após 9/80 ESCORT XR3 - RS TURBO ESCORT D FIESTA 1.1 - 1.3 - 1.4 - 1.6 NOVO FIESTA 1.1 c/ ABS após 89 FIESTA D ORION 1.3 - 1.6 - D
4570051	
6043191 1638320 77TT3A331FA	∅Fg-78 ∅Fp-20 A-100

FOLE DIREITO DA CAIXA DA DIRECÇÃO	
	ESCORT de 9/79 até 5/83 FIESTA até 8/83 ORION de 9/79 até 5/83
4570052	
6047900 6079916 81AB3K661A1A	∅Fg-46 ∅Fp-10 A-130



FOLE DIREITO DA CAIXA DA DIRECÇÃO	
	ESCORT de 9/79 até 5/83 FIESTA até 8/83 ORION de 9/79 até 5/83
4570053	
6047904 77FB3K668A1A	ØF _G -30 ØF _P -10 A-160

FOLE CENTRAL DO AMORTECEDOR ANTERIOR	
	ESCORT FIESTA ORION
4570055	
69AB3025BA 1450821	ØF _G -50 ØF _P -18 A-176

JOGO DE PALAS FORD FIESTA	
	
4570074	
	C-368 L-201

SILENT-BLOC DO BRAÇO SUSPENSÃO ANTERIOR	
	ESCORT FIESTA até 8/83
4570007	
6042743 77FB3432AB	ØF-14 ØE-31.5 A _E -46

SILENT-BLOC DO BRAÇO DE SUSPENSÃO ANTERIOR	
	ESCORT FIESTA até 8/83
4570008	
77FB3063AE 6042740 81AB3063BA	ØF-10 ØE-33 A _i -51

SILENT-BLOC DO BRAÇO SUSPENSÃO ANTERIOR	
	ESCORT ORION FIESTA desde 89
4570009	
6193085 6193086 91AB3A262AA	ØE-54 ØE _A -62 ØF-12 A _i -46

SILENT-BLOC DO BRAÇO DE SUSPENSÃO ANTERIOR	
	ESCORT FIESTA FIESTA D após 89 ORION
4570010	
61938885 61938886 89FB3063ADB492A	ØE-46.5 ØF-12.5 A _i -46

SILENT-BLOC DA SUSPENSÃO	
	MONDEO
4570021	
6870549	ØE-46.5 ØF-12 A-45.5



SILENT-BLOC DA SUSPENSÃO ANTERIOR	
	MONDEO
4570022	
6790115	ØE-47 ØF-12 A-45.5

SILENT-BLOC DE MOLAS TRÁS	
	TRANSIT até 80
4570023	
1575212	ØE-46.5 ØF-18 A-60 A-68

SILENT-BLOC MOLAS TRÁS	
	TRANSIT CAIXA ABERTA RODADO SIMPLES
4570024	
6052013	ØE-46.5 ØF-20 A-60.5 A-67.5

SILENT-BLOC DE MOLAS TRÁS	
	TRANSIT RODADO DUPLO
4570025	
1575045	ØE-46.5 ØF-16 A-60 A-67

SILENT-BLOC DE MOLAS TRÁS	
	TRANSIT MODERNA
4570026	
6152113	ØE-46.5 ØF-18 A-60.5 A-68

SILENT-BLOC DE MOLAS TRÁS OLHAL DA FRENTE	
	TRANSIT MODERNA RODADO DUPLO após 89
4570027	
	ØE-57 ØF-18 A-60 A-72

SILENT-BLOC DE MOLAS TRÁS OLHAL DE TRÁS	
	TRANSIT MODERNA RODADO DUPLO após 89
4570028	
	ØE-50 ØF-16 A-61 A-81

SILENT-BLOC DE MOLAS TRÁS	
	TRANSIT após 80
4570030	
	ØE-46.5 ØF-12 A-61 A-82

TUBO DE RETORNO DE ÁGUA DO AQUECIMENTO	
	FIESTA 0.9 - 1.1
4570044	
1562614	ØF-15

TUBO INFERIOR DE QUATRO VIAS DE SAÍDA DA ÁGUA DO RADIADOR	
	ESCORT de 1/86 A 7/90 ORION 1.4 · 1.6 de 1/86 A 7/90
4570045	
6165328	ØF-33 ØF-17 ØF-17

TUBO SUPERIOR DE ENTRADA DE ÁGUA DO RADIADOR	
	ESCORT de 1/86 A 7/90 ORION 1.4 · 1.6 de 1/86 A 7/90
4570046	
1643126	ØFG-33 ØFP-31.5

TUBO DE RETORNO DA ÁGUA QUENTE 2ª SECÇÃO	
	ESCORT de 1/86 a 7/90 ORION 1.4 · 1.6 de 1/86 a 7/90
4570047	
6153992	ØF-15

TUBO DA ÁGUA QUENTE 1ª SECÇÃO	
	ESCORT de 1/86 a 7/90 ORION 1.4 · 1.6 de 1/86 a 7/90
4570048	
6165793	ØFG-16 ØFP-15

TUBO SUPERIOR DE ENTRADA DE ÁGUA DO RADIADOR	
	FIESTA 1.3 · 1.4 de 9/83 a 89
4570049	
6126535	ØFG-34.5 ØFP-31

TUBO DE RETORNO DE ÁGUA QUENTE	
	FIESTA 1.3 · 1.4 de 9/83 a 89
4570050	
6114432	ØF-15

TUBO INFERIOR DE SAÍDA DE ÁGUA DO RADIADOR	
	FIESTA 1.1 FIESTA 1.3
4570056	
6895397	ØFG-33 ØFP-27

TUBO INFERIOR DE SAÍDA DE ÁGUA DO RADIADOR	
	ESCORT ORION 1.3 ORION 1.6
4570057	
6119164	ØF-31 ØF-31

TUBO SUPERIOR DE ENTRADA DE ÁGUA DO RADIADOR - COM VÁLVULA	
	FIESTA 1.8D
4570058	
6182777	ØF _G -32.5 ØF _P -31

TUBO INFERIOR DE SAÍDA DE ÁGUA DO RADIADOR	
	FIESTA 1.8D
4570059	
6199865	ØF-32.5 ØF-32.5

TUBO SUPERIOR DE ENTRADA DE ÁGUA DO RADIADOR	
	FIESTA 1.1 - 1.3 após 89
4570060	
6895396	ØF _G -32 ØF _P -26

TUBO SUPERIOR DE ENTRADA DE ÁGUA DO RADIADOR	
	ESCORT após 8/90 ORION 1.4 - 1.6 após 8/90
4570061	
6542110	ØF-32 ØF-32

TUBO SUPERIOR DE ENTRADA DE ÁGUA DO RADIADOR - COM VÁLVULA	
	ESCORT 1.8D
4570065	
6481497	ØF-33 ØF-33

TUBO INFERIOR DE TRÊS VIAS DE SAÍDA DE ÁGUA DO RADIADOR	
	ESCORT após 8/90 ORION 1.4 após 8/90 ORION 1.6 após 8/90
4570066	
6690353	ØF-32 ØF-32 ØF-15

TUBO INFERIOR DE TRÊS VIAS DE SAÍDA DE ÁGUA DO RADIADOR	
	ESCORT ORION 1.8D
4570067	
6755964	ØF-32.5 ØF-32.5 ØF-21



TUBO INFERIOR DE SAÍDA DE ÁGUA DO RADIADOR	
	FIESTA 0.9 de 9/83 a 89 FIESTA 1.1 de 9/83 a 89
4570068	
6139472	ØF-31.5 ØF-31.5

TUBO SUPERIOR DE ENTRADA DE ÁGUA DO RADIADOR	
	ESCORT
4570069	
1465390	ØF-37 ØF-31

TUBO INFERIOR DE SAÍDA DE ÁGUA DO RADIADOR	
	ESCORT 1.1 de 81 a 1/86
4570070	
1595579 6115579	ØF-30 ØF-29



CASQUILHO DOS ESTICADORES	
	GALERA FRUEHAUF
4450023	
UJA0033-001	ØE-56 ØF-32 A-59

CASQUILHO DOS BALOIÇOS	
	GALERA FRUEHAUF
4450024	
UJA0030-001	ØE-88 ØF-51 A-110



FOLE DO SEMI-EIXO LADO DA CAIXA DE VELOCIDADES



ACCORD
CIVIC
CIVIC VAN
PRELUDE

4516019

44315-634-003
44315-634-300

ØF_G-74 ØF_P-20
A-81

FOLE DO SEMI-EIXO LADO DA RODA



ACCORD
CIVIC
CIVIC VAN
PRELUDE

4516020

44333-634-003 44333-634-013
44333-634-300

ØF_G-73 ØF_P-24
A-82

SILENT-BLOC DA SUSPENSÃO



CIVIC
CONCERTO

4526001

ØE-80/80.7 ØF-12.5
A-39.7



BATENTE DE MOLA	
	H100
4566039	
55272-43000	A-25 C-103 L-76 ØF-17

FOLE DO SEMI-EIXO LADO DA CAIXA DE VELOCIDADES	
	EXCEL PONY
4516019	
F00122540	ØF _G -74 ØF _P -20 A-81

FOLE DO SEMI-EIXO LADO DA RODA	
	EXCEL PONY
4516020	
F00122530	ØF _G -73 ØF _P -24 A-82



APOIO ANTERIOR DO MOTOR LADO DA DISTRIBUIÇÃO	
	KORAL 45 - 55 - CABRIO
4520032	
7653188 7667850	ØF-12.3 A-54 C-133 L-80

CAPA DE PEDAL DO ACELERADOR	
	KORAL 45 - 55 - CABRIO
4520013	
4187379 SE021110044A	C-96.5 L-43.5

CAPA DE PEDAL DO TRAVÃO E EMBRAIAGEM	
	KORAL 45 - 55 - CABRIO
4520014	
4144275	C-64.5 L-50

CAPA DE PEDAL DO TRAVÃO E EMBRAIAGEM	
	KORAL 45 - 55 - CABRIO
4520056	
4144275	C-64 L-50.5

CAPA DE PEDAL DO TRAVÃO E EMBRAIAGEM	
	ELBA
4525010	
7568442	A-10 C-79.5 L-48

TAMPA DA VARETA DO ÓLEO	
	KORAL 45 - 55 - CABRIO
4520045	
60807644 4102056 4328493	ØE-17 A-42

ESTICADOR DE ESCAPE	
	KORAL 45 - 55 - CABRIO
4520051	
4296059 4312280	ØF-6.5 A-33.5 C-79.5 L-36

SUPORTE POSTERIOR DO TUBO DE ESCAPE	
	ELBA
4530028	
5983764	ØF-4x8.5 A-31 C-87.5 L-26.5



SUPORTE DO TUBO DE ESCAPE	
	MINI DIESEL MINI MINITRE
4575008	
559021235	A-13 C-63 L-52

FOLE DO SEMI-EIXO DIFERENCIAL LADO DA CAIXA DE VELOCIDADES	
	KORAL 45 - 55 - CABRIO
4520046	
92601216 92601171	ØF _G -64 ØF _P -23 A-73

FOLE DIREITO DA DIRECÇÃO	
	ELBA KORAL 45 - 55 - CABRIO MINI
4520040	
4239459 4371156	ØF _G -26 ØF _P -10 A-165

FOLE ESQUERDO DA DIRECÇÃO	
	ELBA KORAL 45 - 55 - CABRIO MINI
4520063	
4239458 4371155	ØF _G -42 ØF _P -10 A-125

SILENT-BLOC DO BRAÇO DE SUSPENSÃO POSTERIOR	
	KORAL
4525019	
4386632	ØE-30 ØE _A -40.5 ØF-13 A-43



APOIO ANTERIOR ESQUERDO DO MOTOR	
	NHR NKR NPR
4516016	
8-94172-019-0	ØP-12 A _P -25 A-49 C-124.5 L-93.5

APOIO ANTERIOR DIREITO DO MOTOR	
	NHR NKR NPR
4516017	
8-94172-018-0	ØP-12 A _P -25 A-49 C-124.5 L-93.5

BATENTE DE MOLA (ISUZU/BEDFORD)	
	NKR
4516022	
	A-15 C-71 L-63 ØP-8 A _P -21

CASQUILHO DE AMORTECEDORES	
	
4516001	
	ØE-30 ØF-15.5 A-20.5

CASQUILHO DE NYLON PARA EXTERIORES SUPLEMENTO DO 4516004	
	KDB 25 - 26 - 27 - 47
4516002	
	ØE-32 ØE _A -42 ØF-30 A-28

CASQUILHO DE MOLAS TRÁS OLHAL DA FRENTE	
	
4516003	
5-51151-007-0	ØE-28 ØE _A -35.5 ØF-18 A-37

CASQUILHO DE MOLAS TRÁS OLHAL DE TRÁS	
	KDB 25 - 26 - 27 - 47
4516004	
894234-319-0	ØE-29.5 ØE _A -37 ØF-18 A-38

CASQUILHO DE MOLA FRENTE	
	NKR NHR
4516005	
894113-314-3	ØE-39 ØE _A -48 ØF-22 A-37

CASQUILHO DE MOLAS TRÁS OLHAL DA FRENTE	
	KDB 25 - 26
4516006	
894223-168-0	∅E-39.5 ∅EA-45 ∅F-18 A-36.5

CASQUILHO DE MOLAS FRENTE	
	MIDI SETA
4516007	
9-94226-805-0	∅E-49.5 ∅EA-57 ∅F-18 A-38

CASQUILHO DE AMORTECEDORES	
	
4516008	
	∅E-25.5 ∅F-10 A-17

CASQUILHO	
	
4516009	
	∅E-36 ∅F-19.5 A-22.5

CASQUILHO	
	
4516010	
	∅E-30 ∅F-10 A-15.5

CASQUILHO	
	
4516011	
	∅E-35 ∅F-19 A-41.5

CASQUILHO	
	
4516015	
	∅E-42 ∅F-17 A-20.5

CASQUILHO DE FERRO PARA EXTERIORES SUPLEMENTO DO CASQUILHO 4516006	
	KBD 25 - 26 - 27 - 47
4516018	
	∅E-43 ∅EA-57.5 ∅F-40 A-29.5

FOLE DO SEMI-EIXO LADO DA CAIXA DE VELOCIDADES	
	GEMINET II GEMINI
4516019	
8-94153-134-0 8-94473-227-0	ØF _G -74 ØF _P -20 A-81

FOLE DO SEMI-EIXO LADO DA RODA	
	GEMINET II
4516020	
8-94153-134-0 8-94473-227-0	ØF _G -73 ØF _P -24 A-82

SILENT-BLOC DE MOLAS	
	NKR RODADO DUPLO
4516012	
	ØE-40 ØE _A -51 ØF-16 A-41

SILENT-BLOC DO BRAÇO SUPERIOR DA SUSPENSÃO	
	FASTER Z KDB 25 · 26 · 27 · 47
4516013	
8-94226-557-2	ØE-36 ØE _A -50.5 ØF-18 A-47

SILENT-BLOC DO BRAÇO INFERIOR DA SUSPENSÃO	
	FASTER Z KBD 25 · 26 · 27 · 47
4516014	
8-94223-366-0	ØE-36 ØE _A -46 ØF-14 A-63.5

SILENT-BLOC DE MOLAS	
	
4516021	
	ØE-42 ØF-16 A _E -72 A _I -81



SUPORTE ANTERIOR DIREITO DO MOTOR	
	DAILY TURBO NOVA DAILY NOVA TURBODAILY TURBODAILY INTERCOOLER
4520115	
8588903	ØP-10 A _P -26 ØF-2x8.5

APOIO POSTERIOR DO MOTOR	
	DAILY TURBO NOVA TURBODAILY TURBODAILY INTERCOOLER
4520116	
8582425	ØF-4x9 ØF-4x8 A-129 L-105

BATENTE DE MOLAS POSTERIOR	
	IVECO EUROTEST
4450083	
	ØP-12 A _P -32 A-25.5 C-91.5 L-80

BATENTE DA BARRA ESTABILIZADORA POSTERIOR	
	DAILY 28.8 - 30.8 DAILY 32.8 - 35.8 DAILY RESTYLING 30.8 DAILY RESTYLING 35.8 DAILY TURBO 35.10 DAILY TURBO 40.10 NOVA TURBODAILY 35.10
4520078	
93803961	ØF-16 A-37 C-40 L-40

BATENTE DA BARRA ESTABILIZADORA POSTERIOR	
	DAILY DAILY R/40.8 DAILY TURBO 40.10 NOVA TURBODAILY TURBODAILY INTERCOOLER 35.12 TURBODAILY INTERCOOLER 49.12
4520095	
93802629	ØF-20 A-37.5 C-40 L-40

BATENTE INFERIOR DA BARRA ESTABILIZADORA POSTERIOR	
	DAILY 40.8 R DAILY TURBO 40.10
4520110	
93802631	ØE-38 ØF-20 A-40

BATENTE DE MOLA POSTERIOR	
	NOVA DAILY TURBODAILY INTERCOOLER 35.12
4520111	
93803992	A-47 C-120.5 L-55

BATENTE SUPERIOR DA BARRA ESTABILIZADORA POSTERIOR	
	DAILY DAILY TURBO NOVA TURBODAILY
4520117	
93801623	ØE-38 ØF-24 A-40

BATENTE INFERIOR DA BARRA ESTABILIZADORA POSTERIOR	
	DAILY 28.8 - 30.8 - 32.8 - 35.8 DAILY RESTYLING 30.8 - 35.8 DAILY TURBO 35.10 - 40.10
4520118	
93803690	∅E-39 ∅F-16 A-40

BATENTE DA BARRA ESTABILIZADORA POSTERIOR	
	TURBODAILY INTERCOOLER 59.12
4520128	
8560291	∅F-28 A-58 C-70 L-62

SUPORTE POSTERIOR DO TUBO DE ESCAPE	
	DAILY R DAILY TURBO NOVA DAILY NOVA TURBODAILY TURBODAILY INTERCOOLER
4525005	
93806171	A-27.5 C-54 L-44

ANEL DE ESCAPE	
	DAILY TURBO NOVA TURBODAILY TURBODAILY INTERCOOLER
4545023	
4422885	∅E-63 A-15

FOLE DA DIRECÇÃO	
	DAILY DAILY TURBO
4520077	
9983323	∅F _G -44 ∅F _P -14 A-190

PALAS DE CAMIÃO	
	IVECO
4450096	
	C-600 L-340

SILENT BLOC DE MOLAS	
	IVECO
4450070	
	∅E-40 ∅E _A -60 ∅F-16.5 A-40

SILENT-BLOC DE MOLAS	
	IVECO TURBODAILY
4450070.1	
	∅E-40 ∅E _A -60 ∅F-16.5 A-35



SILENT-BLOC DE MOLAS	
	IVECO CAMIÃO
4450071	
	ØE-58 ØF-20 A _E -70 A _I -84

SILENT-BLOC DE MOLAS	
	IVECO CAMIÃO
4450119	
98413847	ØE-47 ØF-16 A _E -60 A _I -74

SILENT-BLOC DE MOLAS TRAZEIRA OLHAL DA FRENTE	
	TURBO DAILY
4450122	
	ØE-38 ØF-16 A _E -64.5 A _I -72



CAPA DE PEDAL DO TRAVÃO E EMBRAIAGEM	
	LADA
4520014	
4144275 2101-1602048	C-64.5 L-50

CAPA DE PEDAL DO TRAVÃO E EMBRAIAGEM	
	LADA
4520056	
4144275 2101-1602048	C-64 L-50.5

ESTICADOR DE ESCAPE	
	LADA NIVA
4520051	
2101-1203072 4296059 4312280	ØF-6.5 A-33.5 C-79.5 L-36



APOIO DE MOTOR (DEDRA-POSTERIOR) (DELTA-CENTRAL)	
	DEDRA TD NOVO DELTA TD
4520024	
7642540 60808861 7652240 60594600	ØF-17.5 ØFR-11 A-67.5 L-102

APOIO ANTERIOR DO MOTOR LADO DA DISTRIBUIÇÃO	
	Y10 FL89 velocidades automáticas
4520032	
7653188 7667850	ØF-12.3 A-54 C-133 L-80

APOIO SUPERIOR ESQUERDO DO AMORTECEDOR DA SUSPENSÃO ANTERIOR	
	DEDRA após 8/90 NOVO DELTA
4520035	
7683364 46414184	ØF-12 ØFR-3x8

APOIO POSTERIOR DO MOTOR LADO DA CAIXA DE VELOCIDADES	
	DEDRA 1.6IE NOVO DELTA 1.4-1.6
4520047	
7610157	ØF-10 A-68.5 L-110

APOIO SUPERIOR DIREITO DO AMORTECEDOR DA SUSPENSÃO ANTERIOR	
	DEDRA após 8/90 NOVO DELTA
4520099	
7683363 46414183	ØF-12 ØFR-3x8

SUPORTE SUPERIOR DO AMORTECEDOR ANTERIOR	
	Y após viatura 3301656
4520101	
7775940	ØF-12 ØFR-2x10 A-50

SUPORTE DIREITO DO MOTOR LADO DA CAIXA DE VELOCIDADES	
	Y
4520104	
7765891	ØP-10 A _P -71

SUPORTE POSTERIOR DO MOTOR	
	Y10
4520107	
7544643	ØF-8.5 ØF-2x16 A-64.5 C-131 L-80



APOIO POSTERIOR DO MOTOR	
	Y
4520113	
7784313	ØF-18 ØF-3x16 ØFR-10 A-82

SUPORTE ANTERIOR E POSTERIOR DO MOTOR	
	DELTA 1ª Série PRISMA R/86 1.3 com velocidades auto. PRISMA R/86 1.5 com velocidades auto.
4525003	
SE831154205A	ØF-12.5 A-58 C-135 L-85

BATENTE DA BARRA ESTABILIZADORA ANTERIOR	
	DEBRA NOVO DELTA THEMA
4520109	
7601642	ØE-31 ØF-10 A-19

CASQUILHO DA EXTREMIDADE DA CREMALHEIRA DA DIRECÇÃO	
	DELTA até 6/87 PRISMA até 6/87 Y10 após 91 e exepcto 4x4
4525013	
4330731	ØF-20.5 A-18.5 C-28 L-28

CAPA DE PEDAL DO ACELERADOR	
	DELTA PRISMA
4520013	
4187379 SE021110044A	C-96.5 L-43.5

CAPA DE PEDAL DO TRAVÃO E EMBRAIAGEM	
	Y10
4520014	
4144275	C-64.5 L-50

CAPA DE PEDAL DO TRAVÃO E EMBRAIAGEM	
	Y10
4520056	
4144275	C-64 L-50.5

CAPA DE PEDAL DO TRAVÃO E EMBRAIAGEM	
	NOVO DELTA 1.8 NOVO DELTA 2.0 NOVO DELTA 2.0 TURBO Y
4525010	
7568442	A-10 C-79.5 L-48



TAMPA DA VARETA DO ÓLEO	
	BETA DEDRA 1.6 DEDRA TURBO IE DELTA DELTA R/86 1.3 - 1.5 PRISMA R/86 1.3 - 1.5 THEMA Y 1.2 - Y10 até 91
4520045	ØE-17 A-42
60807644 82305674 4102056 4328493	

BOTÃO DE CAPOT	
	BETA Y10 após 91
4525011	ØE-17 A-43
4276430	

SUPORTE DO TUBO DE ESCAPE (DEDRA-2ª PARTE)	
	DEDRA DEDRA TD Ecológico até 6/90 NOVO DELTA Y10 4x4
4520016	C-60 L-44
5989798	

ESTICADOR DE ESCAPE	
	Y10
4520030	A-42 C-67.5 L-44.5
7600807	

ESTICADOR DE ESCAPE	
	Y
4520031	A-25.5 C-95 L-36
7718578	

ESTICADOR DE ESCAPE	
	Y10 4x4
4520051	ØF-6.5 A-33.5 C-79.5 L-36
4296059 4312280	

SUPORTE DO TUBO DE ESCAPE	
	DEDRA TD até 11/91
4520075	A-14.5 C-59 L-34
7637572	

SUPORTE POSTERIOR DO TUBO DE ESCAPE	
	DEDRA FL94 Gas.
4520076	A-44 C-68.5 L-44.5
7698769	



SUPORTE DO TUBO DE ESCAPE	
	DEDRA 1ª Secção NOVO DELTA 1.4 - 1.6 Y
4520096	
7740653 46421002	∅F-2x8 A-26 C-55 L-38

SUPORTE POSTERIOR DO TUBO DE ESCAPE	
	DEDRA TURBO IE INTEGRALE Y10 após 91 Y10 exepcto 4x4
4525005	
4387293	A-27.5 C-54 L-44

SUPORTE POSTERIOR DO TUBO DE ESCAPE	
	DEDRA NOVO DELTA
4530028	
5983764	∅F-4x8.5 A-31 C-87.5 L-26.5

ANEL DE ESCAPE	
	DEDRA DELTA R/86 NOVO DELTA PRISMA R/86 exepcto 4x4
4545023	
7610077 82409205	∅E-63 A-15

FOLE DO SEMI-EIXO DIFERENCIAL LADO DA CAIXA COM CASQUILHO DE NYLON	
	PRISMA 1.5 de 3/85 a 2/86 Y10 até 9/86
4520028	
92601255	∅F _G -71 ∅F _P -23 A-73

FOLE ESQUERDO DO SEMI-EIXO DIFERENCIAL COM CASQUILHO DE NYLON - LADO DA CAIXA	
	PRISMA 1.5 de 3/85 a 2/86 Y10 até 2/86
4520036	
	∅F _P -25

FOLE ESQUERDO E DIREITO DO SEMI-EIXO DIFERENCIAL LADO DA RODA	
	DELTA 1.3 sem caixa automática DELTA 1.5 sem caixa automática DELTA R/86 1.3 até 6/88 PRISMA 1.3 de 3/85 a 6/88 PRISMA 1.5 de 3/85 a 6/88 Y10 até 12/88
4520038	
5987092	∅F _G -68 ∅F _P -20 A-80

FOLE DIREITO DA DIRECÇÃO VIATURAS SEM DIRECÇÃO ASSISTIDA	
	DELTA 1ª Série desde viatura 293229 DELTA R/86 1.3-1.5-1.6 IE DELTA R/86 TURBO PRISMA D após 6/84
4520040	
4239459 4371156	∅F _G -26 ∅F _P -10 A-165



FOLE DIREITO DA DIRECÇÃO	
	PRISMA 1.3-1.5-1.6 após 6/84 Y10
4520040	
4239459 4371156	∅F _G -26 ∅F _P -10 A-165

FOLE DO SEMI-EIXO DIFERENCIAL LADO DA CAIXA DE VELOCIDADES	
	Y 1.2 LE Y 1.2 LS Y10 RL92 1.1 IE Y10 ELITE
4520041	
7746232	∅F _G -60 ∅F _P -19 A-90

FOLE DO SEMI-EIXO DIFERENCIAL LADO DA CAIXA DE VELOCIDADES	
	DELTA 1.3 DELTA 1.5 DELTA R/86 1.3 DELTA R/86 1.5 PRISMA até 2/85
4520046	
92601216 92601171	∅F _G -64 ∅F _P -23 A-73

FOLE DIREITO DO SEMI-EIXO DIFERENCIAL LADO DA CAIXA DE VELOCIDADES	
	PRISMA de 3/85 a 9/87 Y10 até 9/87
4520046	
92601216 92601171	∅F _G -64 ∅F _P -23 A-73

FOLE DO SEMI-EIXO DIFERENCIAL LADO DA CAIXA DE VELOCIDADES	
	DEDRA 1.6 NOVO DELTA 1.4 - 1.6 Y10 após 10/87
4520054	
7625541	∅F _G -80 ∅F _P -30 A-82

FOLE ESQUERDO DO SEMI-EIXO DIFERENCIAL LADO DA CAIXA DE VELOCIDADES	
	DELTA R/86 1.3 após 10/87 PRISMA R/86 1.3-1.5 após 10/87 PRISMA exepcto caixa automática
4520054	
7625541	∅F _G -80 ∅F _P -30 A-82

FOLE DO AMORTECEDOR ANTERIOR	
	Y
4520059	
7762158 7757917	∅F _G -60 ∅F _P -18 A-200

FOLE DIREITO E ESQUERDO DA DIRECÇÃO	
	DELTA 1ª Série após viat. 293228 PRISMA PRISMA 1.3-1.5 até 87-só esquerdo PRISMA R/86 D-TD só com D.A. Y10 - só esquerdo
4520063	
4239458 4371155	∅F _G -42 ∅F _P -10 A-125



FOLE ESQUERDO E DIREITO DO SEMI-EIXO DIFERENCIAL LADO DA RODA	
	DEDRA 1.6 DELTA R/86 1.3 PRISMA R/86 1.3 - 1.5 Y10
4520071	
7682886	ØF _G -65 ØF _P -19.5 A-81

FOLE ESQUERDO DO SEMI-EIXO DIFERENCIAL LADO DA CAIXA DE VELOCIDADES	
	DELTA R/86 1.3 de 3/86 a 9/87 PRISMA R/86 1.3 até 9/87 PRISMA R/86 1.5 até 9/87 Y10 de 3/86 a 9/87
4520072	
92601366	ØF _G -79 ØF _P -23 A-75

FOLE DO SEMI-EIXO DIFERENCIAL LADO DA RODA	
	DEDRA 1.6 IE após 10/90
4520079	
7635255	ØF _G -75 ØF _P -20 A-104

FOLE DO SEMI-EIXO DIFERENCIAL LADO DA RODA	
	NOVO DELTA 1.4 NOVO DELTA 1.6 Y
4520083	
7761570	ØF _G -78 ØF _P -22 A-81

FOLE DIREITO DO SEMI-EIXO DIFERENCIAL LADO DA CAIXA DE VELOCIDADES	
	DELTA R/86 1.3 PRISMA exepto caixa automática PRISMA R/86 1.3-1.5 após 10/87 Y10 após 10/87
4520085	
7621245	ØF _G -74 ØF _P -30 A-85

FOLE DIREITO DA DIRECÇÃO SEM DIRECÇÃO ASSISTIDA	
	DEDRA 1.6 IE
4520086	
7645160	ØF _G -55 ØF _P -10.5 A-214

KIT FOLE DO SEMI-EIXO DIFERENCIAL LADO DA CAIXA DE VELOCIDADES - EIXO 23mm	
	DEDRA 1.6 DELTA só esquerdo DELTA R/86 1.3 após 10/87 NOVO DELTA 1.4 - 1.6 PRISMA sem caixa automática PRISMA R/86 1.3-1.5 após 10/87 Y10 após 10/87
4520087	
	ØF _G -30 ØF _P -80 A-82

KIT FOLE DO SEMI-EIXO DIFERENCIAL LADO DA CAIXA DE VELOCIDADES - EIXO 23mm	
	DELTA R/86 1.3 após 10/87 Y10 após 10/87
4520088	
	ØF _G -74 ØF _P -30.5 A-86

FOLE CENTRAL DO AMORTECEDOR ANTERIOR	
	Y10
4520122	
5978771	∅F _G -58 ∅F _P -18 A-190

FOLE DO SEMI-EIXO DIFERENCIAL LADO DA CAIXA DE VELOCIDADES	
	BETA DEDRA exopto 1.6 DELTA R/86 1.5 · 1.6 · 2.0 4x4 DELTA R/86 TD NOVO DELTA 1.8 · 2.0 · TD KAPPA 2.0 IE KAPPA 2.0 IE
4565004	
82282140	∅F _G -51 ∅F _P -22 A-81

FOLE DO SEMI-EIXO DIFERENCIAL LADO DA CAIXA DE VELOCIDADES	
	KAPPA 2.0 TURBO IE 16V KAPPA 2.0 TURBO IE 20V LYBRA 1.8 16V LYBRA 2.0 16V
4565004	
82282140	∅F _G -51 ∅F _P -22 A-81

FOLE DO SEMI-EIXO DIFERENCIAL LADO DA CAIXA DE VELOCIDADES	
	PRISMA R/86 com caixa auto. 1.3-1.5 PRISMA R/86 1.6 PRISMA R/86 2.0 IE-INTEGRALE PRISMA R/86 D · TDS THEMA
4565004	
82282140	∅F _G -51 ∅F _P -22 A-81

SILENT-BLOC DIREITO DO BRAÇO DE SUSPENSÃO DIREITO	
	Y
4520034	
7775344	∅F-18.9 A-53 C-103 L-59

BATENTE CENTRAL DA BARRA ESTABILIZADORA ANTERIOR	
	DEDRA IE DEDRA TURBO DEDRA TD NOVO DELTA
4520042	
7635711	∅F-20 A-47 C-59.5 L-48

SILENT-BLOC CENTRAL DO BRAÇO DE SUSPENSÃO	
	Y
4520043	
5927292	∅E-32 ∅E _A -37.5 ∅F-12.1 A-54.75

SILENT-BLOC ANTERIOR DO BRAÇO DE SUSPENSÃO ANTERIOR	
	DEDRA NOVO DELTA
4520052	
7601064	∅F-20 ∅F _R -9 L-49.5



SILENT-BLOC POSTERIOR DO BRAÇO DIREITO DA SUSPENSÃO ANTERIOR	
	DEDRA NOVO DELTA
4520058	
7601068	∅F-19.9 ∅Fr-10 L-52

SILENT-BLOC CENTRAL DA BARRA ESTABILIZADORA ANTERIOR	
	DEDRA 1.8 DEDRA 2.0 IE DEDRA TD
4520060	
7601646	∅F-23 A-47.5 C-41 L-60

SILENT-BLOC ESQUERDO DO BRAÇO DE SUSPENSÃO ESQUERDO	
	Y
4520062	
7775343	∅F-18.8 L-59

SILENT-BLOC POSTERIOR DO BRAÇO DE SUSPENSÃO ANTERIOR ESQUERDA	
	DEDRA NOVO DELTA
4520064	
7601065	∅F-19.8 ∅Fr-10 A-60 L-52.5

TUBO DO AQUECIMENTO COM VÁLVULA	
	Y 1.1 Y 1.2 8V
4520069	
46417275 7755054	∅F-14 ∅F-7

TUBO SUPERIOR DE ENTRADA DE ÁGUA DO RADIADOR	
	Y 1.1 8V 6 Velocidades Y 1.2 16V LE - LS
4520091	
7718664 7770566 7745653 46441019	∅F-26 ∅F-26

TUBO INFERIOR DE SAÍDA DE ÁGUA DO RADIADOR	
	Y 1.1 Y 1.2 8V
4520094	
7797503 7773449 7722856 7760969 7770567 7772356	∅F-28 ∅F-25 ∅F-13.5 ∅F-7

TUBO SUPERIOR DE ENTRADA DE ÁGUA DO RADIADOR	
	DEDRA 1.6 - 1.8IE
4520121	
7609904	∅F-33 ∅F-28



SUPORTE DE MOTOR	
	
4515003	
	ØE-64 ØP-10 Ap-22 A-32.3

SUPORTE DE MOTOR	
	LAND ROVER II
4515004	
	ØP-10 Ap-21 A-37 C-64 L-63.2

CASQUILHO DE AMORTECEDORES	
	
4515006	
278166	ØE-36 ØF-19 A-22.5

CAPA DE PEDAL DO TRAVÃO E EMBRAIAGEM	
	
4515005	
278166	C-101 L-92

SILENT-BLOC DE MOLAS COMPRIDO	
	
4515001	
569746	ØE-30.4 ØF-14.3 Aε-86.1 Aι-92.1

SILENT-BLOC DE MOLAS CURTO	
	
4515002	
569746	ØE-30.4 ØF-14.2 Aε-63.5 Aι-70



APOIO BATENTE DE MOLA MAN (A-125mm)	
	
4450127	
	C-205 L-125 C-205 L-125

SEPARADOR DE MOLAS	
	MAN
4450081	
	A-17.5 C-105 L-88

PALAS DE CAMIÃO	
	MAN
4450093	
	C-600 L-340

SILENT-BLOC DE MOLAS	
	MAN
4450108	
	ØE-70.5 ØF-24 Aε-88 Aι-95

APOIO ANTERIOR DO MOTOR	
	626
4556019	
G03039040B	∅Fr-2x10 ∅P-10 Ap-28 ∅F-2x12

APOIO ANTERIOR DO MOTOR	
	323
4556020	
B00139040E	∅P-10 Ap-27 ∅P-10 Ap-23

APOIO ANTERIOR DO MOTOR	
	626
4556021	
GC07639050A	∅P-10 Ap-77

APOIO DE MOTOR	
	323
4556022	
B00139050	∅P-2x10 Ap-2x23.5 A-42 C-94.5 L-77

APOIO DE MOTOR	
	323
4556023	
B00139050D	∅E-79.5 ∅F-10 ∅F-3x18

APOIO DE MOTOR	
	323
4556024	
B00139070B	∅F-10 ∅Fr-2x10 L-59

APOIO ANTERIOR DO MOTOR	
	323
4556025	
B03739040A	∅P-2x10 Ap-23 Ap-28 L-70

APOIO ANTERIOR DO MOTOR	
	323
4556026	
B03739050	∅P-2x10 Ap-23.5 Ap-23 A-41 C-107 L-75

APOIO ANTERIOR DO MOTOR	
	
4556027	
145639040A	ØP-2x10 A _P -2x23 ØE-117

APOIO ANTERIOR DO MOTOR	
	T3000
4556028	
W02339040A	ØP-2x10 A _P -2x22 A-43.5 C-128

SUPORTE POSTERIOR DO MOTOR	
	T3000
4556029	
W023-39-340A	ØE-36.5 ØE _A -46 ØP-10 A _P -24 A-34

APOIO ANTERIOR DO MOTOR	
	E2700
4556030	
063639040	ØP-2x10 A _P -2x23 A-41 C-136 L-63

APOIO POSTERIOR DO MOTOR	
	E2700
4556031	
063639340	ØP-2x10 A _P -23 A-67 C-93 L-50

APOIO ANTERIOR DO MOTOR	
	808
4556032	
037039040A	ØP-2x10 A _P -2x23 A-33 C-60 L-57

APOIO POSTERIOR DO MOTOR	
	808
4556033	
043739340	ØP-2x10 A _P -2x19 A-48 C-110 L-71

APOIO DO VEIO DE TRANSMISSÃO	
	T3000 T3500
4556036	
W001-25-321	ØF-55 A-128 L-115.5

APOIO DE VEIO DE TRANSMISSÃO	
	1500
4556037	
0223 25 3000	∅E-130 ∅F-52.5 ∅Fr-2x10 L-58.5

APOIO DE MOTOR	
	626
4556038	
	∅F-14.5 ∅P-4x8 A-49.5

BATENTE CENTRAL DA BARRA ESTABILIZADORA	
	E2200
4556006	
S083-34-156	∅F-21 A-41 C-38.5 L-37.5

BATENTE DA BARRA ESTABILIZADORA	
	
4556007	
022334156	∅F-24.5 A-42.5 C-45 L-39.5

CASQUILHO DA BARRA ESTABILIZADORA	
	323
4556011	
B00139811A	∅E-45 ∅F-20 A-21.5

CASQUILHO	
	
4556016	
B00146041	∅E-28.5 ∅EA-32 ∅F-14 A-37

CASQUILHO DE MOLAS TRÁS	
	B2200
4556042	
3784-28-330	∅E-31 ∅EA-37 ∅F-17 A-37.5

CAPA DE PEDAL DO TRAVÃO E EMBRAIAGEM	
	1200 E2500
4556013	
055943028	C-62 L-46.5

CAPA DE PEDAL DO TRAVÃO E EMBRAIAGEM	
	B1600
4556014	
011843028A	C-67 L-50

TAMPA DO ÓLEO	
	323
4556010	
145610250	ØE-69 A-15.5

CARDAN	
	E2700
4556035	
060025061	ØF-6x16 A _F -6x56

ANILHA EM NYLON SUPLEMENTO DO SILENT-BLOC 4556041	
	3000 E2700 T3000 T3500
4556043	
	ØE-51.5 ØF-22 A-3.5

SUPORTE DO TUBO DE ESCAPE	
	121 323 626 929
4556040	
387440060 411240060 8531.40060	ØF-2x8.8

FOLE DO SEMI-EIXO LADO DA CAIXA DE VELOCIDADES	
	323
4516019	
F00122540 F00122540A	ØF _G -74 ØF _P -20 A-81

FOLE DO SEMI-EIXO LADO DA RODA	
	121 323 1500 ETUDE LASER EUNOS 100 - AZ
4516020	
F00122530 F00222530 F00322530A F00322530B	ØF _G -73 ØF _P -24 A-82

CASQUILHO DO BRAÇO DA SUSPENSÃO	
	626
4556001	
817334460	ØE-38.5 ØE _A -47 ØF-12 A-60

CASQUILHO DO BRAÇO DA SUSPENSÃO	
	626
4556002	
G03034460	ØE-25 ØEA-32.5 ØF-10 A-56

SILENT-BLOC DO BRAÇO DA SUSPENSÃO	
	1300
4556003	
031734460	ØE-33 ØEA-39.5 ØF-18 A-27

SILENT-BLOC DO BRAÇO INFERIOR DA SUSPENSÃO	
	323
4556004	
B00134460	ØEA-45 ØF-18 A-56.5

CASQUILHO DO BRAÇO INFERIOR DA SUSPENSÃO	
	323
4556005	
B00134470	ØE-31 ØEA-42 ØF-18 A-52

SILENT-BLOC DE MOLAS FRENTE	
	3000 E2500 E2700 T3000
4556008	
068034330	ØE-35 ØEA-47 ØF-17 A-46

SILENT-BLOC DE MOLAS TRÁS	
	E2500 T3500
4556009	
068028330	ØE-38 ØEA-49.5 ØF-19 A-48.5

SILENT-BLOC DO BRAÇO DA SUSPENSÃO	
	808
4556039	
	ØEm-26.1 ØEA-35 ØF-10.4 A-55.7

SILENT-BLOC DE MOLAS FRENTE E TRÁS	
	3000 E2700 T3000 T3500
4556041	
055934330	ØE-33 ØF-16 A-69 A-75.5



TUBO SUPERIOR DO RADIADOR	
	626
4556017	
E30115186B	

TUBO INFERIOR DO RADIADOR	
	626
4556018	
E30115185A	

SUPORTE ESQUERDO E DIREITO DO MOTOR Série 115 - 123	
	Série 123 · 200 230 230C 230T 250 250T 280E
4545001	
1232410813	∅F _G -13 ∅F _P -8.5 A-56.5 C-123 L-108

SUPORTE ANTERIOR DIREITO E ESQUERDO DO MOTOR	
	Série 123 · 300D 300TD Série 126 · 280 380
4545002	
1232413013	∅F _G -13 ∅F _P -8.5 A-57 C-123 L-107.5

SUPORTE ANTERIOR DO MOTOR	
	Série 123 Série 124 · 200 230 250 Série 201 · 190
4545003	
1242401517/1617/1717	∅E-106 ∅F _R -10 A-109.5

APOIO POSTERIOR DO MOTOR LADO DA CAIXA DE VELOCIDADES	
	Série 201 · 190 desde 10/88
4545013	
2012400718 2012400918 2012401118	∅F _R -2x8 ∅P-12 A _P -23 A-66 C-134 L-80

APOIO BATENTE DE MOLA (A-150mm)	
	ACTROS
4450125	
	C-210 L-135 C-230 L-165

APOIO BATENTE DE MOLA (A-120mm)	
	ACTROS
4450126	
	C-210 L-135 C-230 L-165

SUPORTE ANTERIOR DO MOTOR	
	Série 201 190
4545019	
20124000665	A-53 C-80 L-40

BATENTE DA BARRA ESTABILIZADORA POSTERIOR - SÉRIE 115/123	
	200 - 200 T · 200 D 220 D 230 E · 230 C · 230 CE · 230 TE 240 D · 240 TD 250 T 280 E · 280 C · 280 CE · 280 TE 300 D · 300 TD
4545017	
2013261081	∅F-13 A-35 C-28 L-25



BATENTE DA BARRA ESTABILIZADORA POSTERIOR - SÉRIE 124		
	Série 124	Série 201
	200	190 1.8 E
	230 E	190 2.5 D
	230 TE	
	250 D	
	250 TD	
	300 D	
4545017		
2013261081	ØF-13 A-35 C-28 L-25	

ANILHA DA SUSPENSÃO	
	0302
	0303
	0305
	0307
	0317
	1213
	1313
4545005	1517 Camião
3173331164	ØE-97 ØF-55 A-41

CASQUILHO DE MOLAS	
	FURGÃO
4545008	
3193240750	ØE-42 ØEA-50 ØF-30 A-46

BATENTE DA BARRA ESTABILIZADORA ANTERIOR	
	Série 124
	200
	200D
	200E
	230E
	230CE
4545016	Série 201 190
2013234885	ØE-39.5 ØEA-48 ØF-22 A-37

CAPA DE PEDAL DO TRAVÃO E EMBRAIAGEM	
	FURGÃO
4545004	
3192920082	C-68.5 L-61.5

CAPA DE PEDAL DA EMBRAIAGEM	
	Série 124 - 200 220 230 250 280 300
	Série 201 - 190
	Série 202 - Classe C Classe E
4545010	
	C-69 L-64

CAPA DE PEDAL DO TRAVÃO	
	Série 124 - 200 220 230 250 280 300
	Série 201 - 190
	Série 202 - Classe C Classe E
4545011	
	C-69 L-64

BATENTE DE ESCAPE	
	Série 107 - 280 350 380
	Série 123 - 280 350 380
	Série 124 - 200 220 230 250 280 300
	Série 126 - 260 280 300 38
	Série 201 - 190
4545006	
1239870940	ØE-34 A-34.5



ESTICADOR CENTRAL DO ESCAPE	
	Série 124 · 200 220 230 250 280 300 Série 201 · 190
4545009	
2014920116	ØF _G -18 ØF _P -12 A-18

ANEL DE ESCAPE	
	Série 107 280 · 350 · 380 Série 115/123 200D · 220D 230 · 240 · 250 · 280 Série 124 200 · 230 · 250 · 300 Série 126 260 · 280 · 300 · 380 Série 201 190
4545023	
1124920282 1264920282	ØE-63 A-15

ANEL DE ESCAPE	
	
4545024	
	ØE-70 A-15

FOLE DO SEMI-EIXO DIFERENCIAL LADO DA RODA	
	Série 201 · 190
4545014	
1263500337	ØF _G -58 ØF _P -24 A-95

PALAS DE CAMIÃO	
	MERCEDES
4450094	
	C-600 L-340

SILENT-BLOC DE MOLAS PORTERIOR E ANTERIOR	
	MERCEDES CAMIÃO
4450080	
3230385	ØE-60.5 ØF-22 A _E -68 A _I -76

SILENT-BLOC DE MOLAS	
	MERCEDES CAMIÃO
4450115	
0003220285	ØE-62 ØF-24 A _E -90 A _I -106

SILENT-BLOC DE MOLAS	
	MERCEDES CAMIÃO
4450116	
0003221285 0003222285 0003222185 3753220085	ØE-62.5 ØF-24 A _E -80 A _I -96



SILENT-BLOC DO BRAÇO DE SUSPENSÃO ANTERIOR	
	Série 124 · 200 230 250 300 Série 201 · 190D 190 2.5TD 190 E 1.8 190 E 2.3 190 E 2.6
4545012	
1243333714	∅E-48.5 ∅EA-64.5 ∅F-16.2 A-48.5

SILENT-BLOC DA SUSPENSÃO	
	FURGÃO MB
4545007	
0003210050	∅EA-38 ∅F-12 A-70

TUBO INFERIOR DE TRÊS VIAS DE SAÍDA DE ÁGUA DO RADIADOR	
	Série 124 · 200 E
4545015	
1245013882	∅F-33 ∅F-29 ∅F-25

SILENT-BLOC DO BRAÇO DE SUSPENSÃO ANTERIOR	
	Série 124 Série 201 200D 190 200E 230E 250D 250TD 300D 300E
4545018	
201335114	∅E-48.5 ∅EA-64.5 ∅F-16 A-48.5

TUBO SUPERIOR DE ENTRADA DE ÁGUA DO RADIADOR - de 72 a 8/76	
	Série 123 200 200D 220 220D 230/4 240D
4545021	
1155011182	∅F-33 ∅F-29

TUBO INFERIOR DE SAÍDA DE ÁGUA DO RADIADOR	
	Série 123 200 200D 200 220D 230/4 240D
4545020	
1235010482	∅F-34 ∅F-34

TUBO SUPERIOR DE ENTRADA DE ÁGUA DO RADIADOR-APÓS 9/76	
	Série 123 200 200 D 220 220 D 230/4 240 D
4545022	
1235010082 1235010882	∅F-34 ∅F-34

SUPORTE ANTERIOR DIREITO E ESQUERDO DO MOTOR	
	CANTER FE331/444 T210
4566002	
ME011832 ME011836	ØP-2x12 A _P -2x27 A-40 C-123.5 L-68

SUPORTE ANTERIOR DO MOTOR	
	2000 GALANT
4566012	
MB 006759	ØP-10 A _P -23.5 A-58 L-115.5

SUPORTE ANTERIOR DO MOTOR	
	L200 D
4566013	
MB007023	ØP-10 A _P -23 A-54 L-115

SUPORTE POSTERIOR DO MOTOR	
	LANCER
4566014	
MA180520	ØF-2x12 ØF-4x10 A-92 C-138 L-80

APOIO POSTERIOR DO MOTOR	
	GALANT
4566015	
MB 006602	ØF-2x10 ØF _R -2x10 A-74 C-178 L-50

APOIO ANTERIOR DO MOTOR	
	
4566016	
MB 201952	ØP-2x10 A _P -2x19 A-44 C-50 L-50

BATENTE - COM ROLAMENTO	
	LANCER
4566017	
MB 109866	ØP-4x8 ØF-15 A-56 C-142 L-114.5

APOIO DO VEIO DE TRANSMISSÃO COM ROLAMENTO	
	L021 PICK UP L200 K14
4566018	
MB 154199	ØF-30 C-205 L-59



APOIO AUXILIAR DA CAIXA TRASEIRO	
	
4566041	
	ØP-10 A _P -22 ØF-10 A-48 C-99 L-56.5

APOIO MOTOR FRENTE DIREITO	
	L200D STRADA
4566048	
	ØF-2x14.5 ØP-10 A _P -19.5 A-51 C-101 L-114.5

BATENTE DE MOLA	
	CANTER T210
4566003	
Mb025126	A-64 C-168 L-85

BATENTE DE MOLA POSTERIOR	
	CANTER T210
4566004	
Mb116187	ØF-2x9 A-66.5 C-117 L-58

BATENTE DE MOLA POSTERIOR	
	FUSO
4566005	
17255-57500	ØF _R -2x12 A-73 C-151 L-78

BATENTE DE MOLA POSTERIOR	
	FUSO
4566006	
12255-42101	ØF _R -2x12 A-48 C-151 L-78

BATENTE DE MOLA POSTERIOR	
	L200 4x2 K14T K34T
4566021	
MB 111253	A-105 C-96 L-71

BATENTE DE MOLA	
	CANTER
4566026	
MB 104718	ØP-2x8 A-16 C-72 L-72

SEPARADOR DE MOLAS	
	CANTER FE 31 CANTER FE 44
4566033	
	A-15 C-72 L-50.5

BATENTE DA BARRA ESTABILIZADORA	
	L200
4566036	
MB 109557	ØF-25 A-38 C-38 L-36

BATENTE DE MOLAS	
	CANTER
4566038	
	A-81 C-93 L-66.5

BATENTE SUPERIOR DO BRAÇO SUSPENSÃO FRENTE	
	STRADA
4566044	
	ØE-75 ØP-10 Ap-18.5 A-69

BATENTE BARRA ESTABILIZADORA	
	PAGERO
4566045	
	ØF-26 A-43 C-36.5 L-45.5

BATENTE BARRA ESTABILIZADORA FURO 24mm	
	PAGERO
4566046	
	ØF-24 A-45 C-39.5 L-45.5

BATENTE SUSPENSÃO	
	
4566047	
	ØF-2x9 A-31 C-86 L-43.5

BATENTE BARRA ESTABILIZADORA DIRTEITA	
	
4566049	
	ØE-60 ØF-25 A-27.5



CASQUILHO DE MOLA	
	GALANT LANCER PAJERO L200
4566009	
MB111203	ØE-32 ØEA-37.5 ØF-17.5 A-42.5

CASQUILHO DE MOLA	
	GALANT LANCER L200
4566010	
MB111070	ØE-27 ØEA-37 ØF-15.5 A-46

CASQUILHO DE MOLAS POSTERIOR	
	L200
4566027	
MB584530	ØE-27.5 ØEA-35 ØF-16 A-45

CASQUILHO DE MOLAS POSTERIOR	
	L300
4566028	
MB584531	ØE-27.5 ØEA-35.5 ØF-16 A-55

CASQUILHO DE MOLAS	
	PAJERO
4566034	
MB111203	ØE-32 ØEA-38 ØF-18 A-45

CASQUILHO DO BRAÇO INFERIOR DA SUSPENSÃO	
	L200
4566035	
MB 109529	ØE-38 ØF-17.5 A-45

TAMPA DO ÓLEO	
	GALANT LANCER
4566007	
MD000520	ØE-76 A-38

TAMPA DO ÓLEO	
	GALANT LANCER
4566008	
MD000784	ØE-69 A-26



FOLE DO SEMI-EIXO LADO DA CAIXA DE VELOCIDADES	
	DIAMANTE SIGMA GALANT E ETERNA E CHARIOT TREDIA CORDIA PAJERO
4516019	
MB297536 MB526471 MB620330 MB526401	ØF _G -74 ØF _P -20 A-81

FOLE DO SEMI-EIXO LADO DA RODA	
	GALANT ETERNA CHARIOT LANCER MIRAGE
4516020	
MB526330 MB820090 MB526862 MB178800 MB297184 MB297147 MB106011 MB178182 MB297190	ØF _G -73 ØF _P -24 A-82

FOLE DE PROTECÇÃO DA CREMALHEIRA DA DIRECÇÃO	
	ETERNA GALANT ECLIPSE MIRAGE LANCER
4566037	
MB350581 MB501711	ØF _G -49 ØF _P -12 A-170

SILENT-BLOC	
	GALANT
4566019	
MB 001620	ØE-33 ØE _A -42 ØF-16 A-32.5

SILENT-BLOC DA SUSPENSÃO	
	1400 LANCER
4566020	
MB 109786	ØE-30 ØE _A -40 ØF-12 A-59

SILENT-BLOC DA SUSPENSÃO	
	
4566022	
MB 002998	ØE-39.5 ØF-12 A-45

SILENT-BLOC DA SUSPENSÃO	
	
4566023	
MB 111040	ØE-56.5 ØF-16 A _E -50 A _R -60.5

SILENT-BLOC DA SUSPENSÃO	
	
4566024	
MB 111041	ØE-51 ØF-16 A-50



SILENT-BLOC DA SUSPENSÃO	
	
4566025	
MB 111173	ØE-46 ØF-16 A-60.5

SILENT-BLOC DE MOLAS	
	L200 4x4
4566029	
	ØE-36 ØF-14 A _E -70 A _r -79.5

SILENT-BLOC DE MOLAS	
	L300
4566030	
	ØE-40 ØF-14 A _E -70 A _r -79.5

SILENT-BLOC DE MOLAS	
	L300
4566032	
	ØF-14 A _E -68 A _r -78.5 C-75 L-55

TUBO RADIADOR	
	
4566043	
	ØF-33 ØF-33

APOIO ANTERIOR DO MOTOR	
	PICK-UP
4586001	
11221-C6001	ØP-12 A _P -27 ØF-2x13 A-48 C-139 L-108

APOIO ANTERIOR DO MOTOR	
	521
4586003	
11228-14801	ØP-2x8 A _P -2x18 A-50 C-111 L-56

APOIO POSTERIOR DO MOTOR	
	520
4586004	
11320-28000	ØF-6x10 A-69.5 C-133 L-93

APOIO ANTERIOR DO MOTOR	
	620 Motor SD 22
4586005	
11220-B8000	ØP-10 A _P -22 A-46 C-96 L-98

APOIO INFERIOR ESQUERDO DA PARTE ANTERIOR DO MOTOR	
	DATSUN 720 Motor SD 23
4586006	
11221-09W01	ØP-2x12 A _P -2x26.5 A-57.5 C-104 L-60

APOIO ANTERIOR DIREITO DO MOTOR	
	DATSUN 720 Motor SD 23
4586007	
11220-09W01	ØP-12 A _P -27.5 A-57.5 C-110 L-126

APOIO ANTERIOR DO MOTOR	
	DATSUN D21 - TD 25
4586008	
11210-18601	ØP-10 A _P -21 A-67 C-117 L-152

SUPORTE DA CAIXA DE VELOCIDADES	
	620 Motor SD 22
4586010	
11320-B5000 11320-B5001	ØF _R -2x10 ØF-2x13 A-61 C-135 L-76.5

SUPORTE DA CAIXA DE VELOCIDADES	
	DATSUN D21 - TD 25 - 2WD Motor SD 23
4586011	
11320-01G00	ØP-2x10 A _P -2x24 A-67 C-135 L-103.5

APOIO DO VEIO DE TRANSMISSÃO	
	620
4586012	
37521-B5000 37521-B5025	ØE-121 ØF-30 A-62.5

APOIO DO VEIO DE TRANSMISSÃO	
	DATSUN 720
4586013	
37522-01W00	ØE-120 ØF-30 A-47

APOIO DO VEIO DE TRANSMISSÃO	
	PICK-UP
4586050	
34521-00125	

APOIO	
	PICK-UP
4586054	
54467-Y8001	ØF-18 A-63 C-74 L-64

APOIO ANTERIOR DO MOTOR	
	SUNNY
4586056	
11210-01A02B	

APOIO POSTERIOR DO MOTOR	
	SUNNY
4586057	
11320-01A02AB	

APOIO	
	SUNNY
4586058	
11350-01A04	



APOIO POSTERIOR DO MOTOR	
	DATSUN 130Y
4586059	
11320-11A00	

APOIO ANTERIOR DO MOTOR	
	SUNNY
4586060	
11223-H9100	

APOIO POSTERIOR DO MOTOR	
	SUNNY
4586061	
11320-W5000	

APOIO ANTERIOR DO MOTOR	
	SUNNY
4586062	
11223-H1000	

APOIO ANTERIOR DO MOTOR	
	BLUEBIRD
4586067	
11220-W1010	

APOIO POSTERIOR DO MOTOR	
	BLUEBIRD
4586068	
11320-W1000B	

APOIO ANTERIOR DO MOTOR	
	BLUEBIRD
4586074	
11220-A3500	

APOIO POSTERIOR DO MOTOR	
	BLUEBIRD
4586075	
11320-21002	



APOIO POSTERIOR DO MOTOR	
	BLUEBIRD
4586076	
11320-U2010	

APOIO POSTERIOR DO MOTOR	
	BLUEBIRD
4586077	
11320-P4400	

BATENTE ANTERIOR DE MOLA, INFERIOR	
	DATSUN 720
4586022	
54050-B9500	ØP-8 A-18 A-44 C-72 L-69

BATENTE ANTERIOR DE CAPOT	
	DATSUN 620
4586023	
65805-B5000	A-41 C-25 L-29

BATENTE POSTERIOR DE CAPOT	
	DATSUN 620
4586024	
65806-B5000	A-41 C-25 L-29

BATENTE ANTERIOR DIREITO DE MOLA	
	
4586037	
54053-E9000	ØP-8 A-18 A-35 C-42.5 L-27

BATENTE ANTERIOR ESQUERDO DE MOLA	
	
4586038	
54054-E9000	ØP-8 A-18 A-35 C-42.5 L-27

BATENTE DA BARRA ESTABILIZADORA	
	PICK-UP
4586055	
54613-V0101	ØF-20 A-42 C-34 L-28

BATEENTE DA BARRA ESTABILIZADORA	
	SUNNY
4586063	
54617-H1001	ØF-20 A-34 C-38 L-29

BATEENTE DE CAPOT	
	BLUEBIRD
4586080	
65806-H5000	

BATEENTE DA BARRA ESTABILIZADORA	
	BLUEBIRD
4586083	
54617-21002	ØF-17 A-39 C-38 L-34

BATEENTE DE MOLAS	
	CABSTAR F 22 CABSTAR BH 40 CABSTAR H 40
4568085	
55207-T9021	ØP-8 A _P -22 C-97.5 L-86.5

BATEENTE DA BARRA ESTABILIZADORA	
	PICK-UP 620 PICK-UP 720
4586107	
54613-14900	ØF-21 A-39 C-37.5 L-34

BATEENTE DA BARRA ESTABILIZADORA	
	PICK-UP D21 2x4 e 4x4
4586108	
54613-W1410	ØF-22.5 A-38.5 C-32 L-27.5

BATEENTE DE MOLA	
	PATROL
4586110	
	A-4 C-72 L-50

CASQUILHO	
	DATSUN 720 TD 25
4586031	
54476-01L00	ØE-51.5 ØF-16 A-32.5

CASQUILHO DA CAIXA DE VELOCIDADES	
	SUNNY
4586046	
32855-H1010	∅E-12 ∅E _A -18 ∅F-9 A-10

CASQUILHO DA BARRA DE TORÇÃO	
	PICK-UP
4586052	
54476-W1010	∅E-53 ∅F-16.5 A-26

CASQUILHO DA BARRA DE TORÇÃO	
	PICK-UP
4586053	
54477-W1010	∅E-53 ∅F-16.5 A-26

APOIO DO AMORTECEDOR	
	BLUEBIRD
4586078	
54321-01A01	∅E-61 ∅F-12 A-31

CASQUILHO DA SUSPENSÃO	
	BLUEBIRD
4586081	
54535-22008	∅E-40 ∅F-14 A-23.5

CASQUILHO	
	BLUEBIRD
4586084	
54467-21000	∅E-51 ∅F-17 A-28

CASQUILHO DE MOLAS ANTERIOR	
	CABALL
4586087	
35129-4401-P	∅E-32 ∅E _A -40.5 ∅F-19 A-44.5

CASQUILHO DE MOLAS POSTERIOR	
	CABALL
4586088	
	∅E-35.5 ∅E _A -45.5 ∅F-21.5 A-45

CASQUILHO DE MOLAS POSTERIOR	
	CABALL
4586089	
55046-76000	∅E-32 ∅E _A -36 ∅F-19 A-41

CASQUILHO DE MOLAS POSTERIOR OLHAL DE TRÁS	
	PICK UP 720 URVAN
4586090	
55045-01W10 55045-01W10LP	∅E-40 ∅E _A -48 ∅F-17 A-37

CASQUILHO DE MOLAS	
	CABSTAR F 22
4586091	
55045-T3000	∅E-34.5 ∅E _A -44 ∅F-18 A-46

CASQUILHO DE MOLAS POSTERIOR OLHAL DA FRENTE	
	PATROL PICK UP
4586092	
55046-01W10LP	∅E-34 ∅E _A -38 ∅F-17.5 A-38.5

CASQUILHO DE MOLAS POSTERIOR OLHAL DA FRENTE	
	PICK UP 720
4586093	
55046-01W00 55046-01W10	∅E-34.5 ∅E _A -38 ∅F-15 A-38

CASQUILHO DE MOLAS	
	PICK UP D 21
4586094	
55046-01G00	∅E-33 ∅E _A -37 ∅F-20 A-37

CASQUILHO DE MOLAS POSTERIOR PARTE DA FRENTE	
	VANETT
4586095	
55045-G2500	∅E-44 ∅E _A -50 ∅F-18 A-38.5

CASQUILHO DE MOLAS POSTERIOR PARTE DE TRÁS	
	VANETT
4586096	
55046-G8300	∅E-28 ∅E _A -31 ∅F-14.5 A-39

CASQUILHO DE MOLAS POSTERIOR	
	PATROL
4586097	
55046-G9600	ØE-32.5 ØEA-38 ØF-18 A-51

CASQUILHO DE MOLAS POSTERIOR	
	CABSTAR RODADO SIMPLES
4586099	
35129-6403P	ØE-28 ØEA-32 ØF-17.5 A-44.5

CASQUILHO DE MOLAS	
	PATROL
4586100	
55046-R8000	ØE-33 ØEA-36.5 ØF-18 A-39

CASQUILHO ANTERIOR DE MOLAS	
	PICK-UP D21
4586101	
54476-01G00	ØE-51 ØF-21.5 A-36

CASQUILHO DO ESTICADOR DA SUSPENSÃO	
	720
4586102	
54476-F0200	ØE-51 ØF-21.5 A-35

CASQUILHO DA BARRA ESTABILIZADORA	
	1200 100 A 120 Y
4586103	
56125-18100	ØE-22 ØF-8 A-14

CASQUILHO DE MOLAS - TRÁS OLHAL DE TRÁS	
	DATSUN 1200 B110 - B210
4586109	
55045-H1000	ØE-34 ØEA-40 ØF-11.5 A-34.5

CAPA DE PEDAL DO TRAVÃO E EMBRAIAGEM	
	DATSUN 620
4586032	
46431-04100	A-10 C-65 L-48

COBERTURA PARA ALAVANCA DE VELOCIDADES	
	DARSUN 521
4586017	
34115-73200	ØE-20 ØF-9 A-32

COBERTURA INFERIOR DA JUNTA	
	DATSUN 720
4586019	
40192-73000	

BATENTE ANTERIOR DE MOLLA, SUPERIOR	
	DATSUN 620
4586020	
54053-04301	ØE-31.5 A-47

BATENTE ANTERIOR DE CAPOT	
	DATSUN 720
4586025	
62840-V0100	ØE-21.5 A-28.5

TAMPA DO ÓLEO	
	SUNNY
4586071	
15255-T8200	

SUPORTE DO TUBO DE ESCAPE	
	DATSUN 720
4586034	
42012-0101P	ØF-2x10 A-11.5 C-92 L-33

ESTICADOR DE ESCAPE	
	URVAN VANNETE até 87
4586043	
20650-D0100 20650-V5000 20650-V5200 20650-41L00	ØF-2x12 A-35 C-70 L-60

ESTICADOR DO TUBO DE ESCAPE	
	PICK-UP
4586051	
20640-01A01	ØF-2x12 A-19.5 C-59 L-43



FOLE DO SEMI-EIXO LADO DA CAIXA DE VELOCIDADES	
	SUNNY MICRA PULSAR LANGLE MARCH FIGARO CHERRY
4516019	
39155-M7225 39741-11025 40089-M0826 39741-11M00	∅F _G -74 ∅F _P -20 A-81

FOLE DO SEMI-EIXO LADO DA RODA	
	SUNNY LAUREL SPIRIT PULSAR LANGLE LIVERT VILLA MARCH FIGARO
4516020	
39241-11M00 39241-11M25 39241-44B25	∅F _G -73 ∅F _P -24 A-82

FOLE DE PROTECÇÃO DA CREMALHEIRA DA DIRECÇÃO	
	SUNNY PULSAR PRIMERA PRESEA CEFIRO BLUEBIRD LARGO VANETTE
4566037	
48203-0E025	∅F _G -49 ∅F _P -12 A-170

FOLE DA EMBRAIAGEM	
	620
4586014	
30542-21000	

FOLE DA ALAVANCA DE VELOCIDADES	
	DATSUN 620
4586015	
74963-15800	

FOLE DA ALAVANCA DAS VELOCIDADES	
	DATSUN 720
4586016	
74963-H5000	

FOLE DA CAIXA DE VELOCIDADES	
	DATSUN 120Y
4586036	
32962-24900	

FOLE DA EMBRAIAGEM	
	NISSAN 720 Motor SD22-SD23 Motor SD23 TD25 620 BLUEBIRD 910 CABSTAR F22 Motor TD25 CABSTAR DH40
4586039	
30542-E9000 73J25-4F425	



FOLE DA ALAVANCA DAS VELOCIDADES	
	SUNNY
4586064	
74963-20900	

SILENT-BLOC POSTERIOR DA SUSPENSÃO	
	DATSUN 320
4586026	
55045-07200	ØE-33 ØF-16 A-65

SILENT-BLOC POSTERIOR DA SUSPENSÃO	
	DATSUN 620
4586027	
55045-B5000	ØE-41 ØF-16 A _E -60 A _r -70

SILENT-BLOC DO BRAÇO INFERIOR DA SUSPENSÃO	
	DATSUN 620
4586028	
54423-04300	ØE-36 ØF-18 A _E -64 A _r -68

SILENT-BLOC DO BRAÇO SUPERIOR DA SUSPENSÃO	
	DATSUN 720
4586029	
54506-B9500	ØE-47 ØF-18 A-48

SILENT-BLOC DO BRAÇO INFERIOR DA SUSPENSÃO	
	DATSUN 620 - 720
4586030	
54423-B9500	ØE-36 ØF-18 A _E -64 A _r -81

SILENT-BLOC DO BRAÇO INFERIOR DA SUSPENSÃO	
	PICK-UP
4586035	
55045-00103	ØE-45 ØE _A -58 ØF-14 A-60

SILENT-BLOC DO BRAÇO INFERIOR DA SUSPENSÃO	
	SUNNY
4586065	
54131-H1000	ØE-28.5 ØF-10 A-68



SILENT-BLOC DA SUSPENSÃO	
	SUNNY
4586069	
54504-01A10	ØE-36 ØF-16 A _E -50 A _r -60

SILENT-BLOC DA SUSPENSÃO	
	SUNNY
4586070	
54505-01A10	ØE-41 ØF-16 A _E -50 A _r -60

SILENT-BLOC DA SUSPENSÃO	
	SUNNY
4586072	
54460-G0300	ØE-34 ØF-13 A-113.5

CASQUILHO DO BRAÇO SUPERIOR DA SUSPENSÃO	
	SUNNY
4586073	
54450-G0300	ØE-34.5 ØE _A -40.5 ØF-16 A-46

SILENT-BLOC DA SUSPENSÃO	
	BLUEBIRD
4586082	
54535-A0801	ØE-35 ØF-14.5 A _E -37.5 A _r -45

SILENT-BLOC DO MOLAS POSTERIOR	
	PICK UP D21 4x4
4586086	
54560-01G00	ØE-40 ØF-18 A _E -60 A _r -69.5

SILENT-BLOC INFERIOR DA MOLLA DA FRENTE	
	620 720
4586104	
54423-B9500	ØE-36 ØF-18 A _E -64 A _r -81

SILENT-BLOC DO BRAÇO SUPERIOR DA SUSPENSÃO	
	720
4586105	
54506-B9500	ØE-41 ØE _A -47 ØF-17.5 A-48



SILENT-BLOC DO BRAÇO DE SUSPENSÃO POSTERIOR	
	SUNNY N13 de 87 a 90
4586106	
55157-50A10	ØE-34.5 ØF-14 A-40

SILENT-BLOC DE MOLAS	
	VANETTE
4586111	
	ØE-40 ØF-12 A-60 A-70

TUBO DA BOMBA DE ÁGUA	
	BLUEBIRD
4586040	
14055-W5800	

TUBO DA BOMBA DE ÁGUA	
	BLUEBIRD
4586041	
14080-N5804	

TUBO DE ÁGUA	
	BLUEBIRD
4586042	
14055-W8800	

TUBO INFERIOR DE RADIADOR	
	SUNNY
4586044	
21506-H1101	

TUBO SUPERIOR DE RADIADOR	
	SUNNY
4586045	
21501-01A00	

TUBO SUPERIOR DE RADIADOR	
	TRUCK
4586048	
21501-36W00	



TUBO INFERIOR DE RADIADOR	
	TRUCK
4586049	
21503-36W00	

SUPORTE ESQUERDO DO MOTOR	
	CORSA A 1.5D CORSA A 1.5TD CORSA B 1.5D CORSA B 1.5TD
4540007	
684280	ØP-10 A _P -20 ØF-10.5 L-69.5

SUPORTE TRASEIRO DO MOTOR	
	CORSA A 1.5D CORSA A 1.5TD CORSA B 1.5D CORSA B 1.5TD KADETT
4540008	
682555	ØF-10.3 A-85 L-66

APOIO ANTERIOR DIREITO DO MOTOR	
	ASTRA 1.8 ASTRA 2.0 ASTRA D
4540015	
684283	ØF-2x13 ØF-2x11.5 A-95 L-66.5

APOIO ANTERIOR DIREITO DO MOTOR	
	ASTRA 1.4 ASTRA 1.6
4540016	
684282	ØF-2x13 ØF-2x11.5 A-95 L-66.5

APOIO POSTERIOR DO MOTOR	
	CORSA B 1.4 KADETT E
4540017	
682594 90189509	ØF-10.5 A-82 L-66

APOIO POSTERIOR DO MOTOR	
	ASTRA 1.4 ASTRA 1.6 ASTRA TD VECTRA 1.4 VECTRA 1.6 VECTRA TD
4540018	
682601 90473852 684648	ØP-2x10 ØF-4x11 A _P -2x18.5 A-98.5 L-56

APOIO POSTERIOR DO MOTOR	
	ASTRA D VECTRA 1.8 VECTRA 2.0 VECTRA D
4540019	
682504 90447883 682558	ØP-2x10 ØF-4x11 A _P -2x18.5 A-98.5 L-56

APOIO ANTERIOR ESQUERDO DO MOTOR	
	ASTRA 1.4 ASTRA D VECTRA D
4540020	
684289 90236838	ØF _R -2x10 A-92 L-63

APOIO ANTERIOR DIREITO DO MOTOR	
	KADETT E 1.6D
4540022	
684265 684267	∅F-2x10 ∅Fr-3x10 A-91.5 C-96 L-118

SUPORTE ANTERIOR DIREITO DO MOTOR	
	CORSA B
4540038	
684294	∅F-2x10 ∅F-2x12.5

APOIO ANTERIOR DIREITO DO MOTOR	
	ASTRA TD VECTRA TD
4540039	
684644	∅F-2x12.5 ∅Fr-2x10

APOIO ANTERIOR DIREITO DO MOTOR	
	CORSA A KADETT E 1.2 · 1.3 · 1.4
4540040	
684195	∅Fr-2x10 ∅P-2x10 Ap-2x26 A-90.5 C-114.5 L-51

APOIO SUPERIOR DO AMORTECEDOR ANTERIOR	
	KADETT E 1.2 · 1.3 · 1.4 · 1.6
4540041	
3445081	∅F-14 ∅P-2x8 Ap-2x15.5 A-46 L-130

SUPORTE ANTERIOR ESQUERDO DO MOTOR	
	CORSA B
4540042	
684669	∅Fr-10 A-91 C-157 L-60.5

SUPORTE POSTERIOR DO MOTOR	
	CORSA B
4540043	
682600	∅F-10.5 A-85 L-66

SUPORTE ANTERIOR ESQUERDO DO MOTOR	
	ASTRA TD VECTRA TD
4540044	
684643 90372699	∅F-2x8.5 A-89 L-63



SUPORTE POSTERIOR DO MOTOR	
	CORSA
4540048	
682552 90223327	ØF-10.5 ØF-9.5 A-85 C-145 L-66

APOIO DO AMORTECEDOR ANTERIOR	
	CALIBRA 2.0 VECTRA
4540051	
344514	ØE-115 ØF-16 A-45.5

SUPORTE DE ESCAPE	
	CORSA
4540010	
	ØF-10 A-24 C-36 L-32

BATENTE CENTRAL DO AMORTECEDOR ANTERIOR - POLIURETANO	
	ASTRA KADETT D exepcto 16V KADETT E exepcto 16V REKORD E
4540026	
344401	ØE-66 ØFg-27 ØFp-19.5 A-68

BATENTE DA BARRA ESTABILIZADORA ANTERIOR	
	ASTRA VECTRA
4540036	
350081	ØF-18 A-33 C-39.5 L-42.5

CASQUILHO PARA O SUPORTE DE ESCAPE	
	ASCONA C CORSA A CALIBRA OMEGA A RECORD D Diesel VECTRA
4540011	
856700	ØE-28 ØE-25 ØF-11.5 A-13

BATENTE LATERAL DA BARRA ESTABILIZADORA ANTERIOR	
	ASCONA C ASTRA KADETT D KADETT E REKORD E VECTRA
4540023	
350153	ØE-30 ØF-8 A-20

CAPA DE PEDAL DO TRAVÃO E EMBRAIAGEM	
	ASCONA C ASTRA CORSA A 1.0 - 1.2 - 1.3 CORSA B 1.2 - 1.4 - 1.6 KADETT E VECTRA
4540006	
560808	A-10 C-59 L-55.5

ESTICADOR DE ESCAPE	
	CALIBRA após 90 COMMODORE C após 78 CORSA após 83 KADETT E após 85 KADETT COMBO de 85 a 90 MONZA de 78 a 87 OMEGA após 86 REKORD E
4540001	
852715 852716 852720	A-16 C-65 L-50

SUPORTE POSTERIOR DO ESCAPE	
	KADETT D 1.0 KADETT D 1.2 KADETT 1.6D
4540002	
852717 852718	A-30,5 C-105 L-35,4

SUPORTE ANTERIOR DO ESCAPE	
	ASTRA CORSA A 1.0 · 1.2 · 1.3 CORSA B 1.2 · 1.4 · 1.6 VECTRA
4540005	
852722	A-42 C-74 L-48.5

SUPORTE POSTERIOR DO ESCAPE	
	ASCONA B ASTRA 1.4 · 1.6 · 1.8 · 2.0 ASTRA 1.7D ASTRA 1.7TD CORSA KADETT C MANTA B
4540009	
856519	∅F-2x6 A-41.5 C-43.5 L-43

SUPORTE CENTRAL E POSTERIOR DO ESCAPE	
	KADETT D 1.0 KADETT D 1.2 KADETT 1.6 Diesel
4540027	
852717 90091697 852718	A-31.5 C-106 L-23

FOLE DO SEMI-EIXO DIFERENCIAL LADO DO RODA	
	ASTRA 1.8 · 2.0 · D · TD ASCONA C 1.6 · 1.8 ASCONA C Diesel KADETT D KADETT D 1.8 · 2.0 · Diesel VECTRA 1.8 · 2.0 · D · TD
4540021	
374050 90125901	∅F _G -82 ∅F _P -22 A-78

FOLE DO SEMI-EIXO DIFERENCIAL LADO DA CAIXA DE VELOCIDADES	
	ASCONA C 1.0 · 1.2 · 1.3 ASCONA C desde 9/81 ASTRA 1.4 · 1.6 · D KADETT D 1.0 · 1.2 · 1.3 KADETT E 1.2 · 1.3 · 1.6 KADETT Diesel MANTA C desde 8/79 VECTRA 1.4 · 1.6 · D
4540024	
374018 90095162	∅F _G -55 ∅F _P -19 A-98

FOLE ESQUERDO E DIREITO DA DIRECÇÃO	
	CORSA
4540028	
902826	∅F _G -50 ∅F _P -12 A-175



FOLE DO SEMI-EIXO DIFERENCIAL LADO DA RODA	
	CORSA
4540029	
374094	ØF _G -78 ØF _P -23 A-110

FOLE DO SEMI-EIXO DIFERENCIAL LADO DA CAIXA DE VELOCIDADES	
	ASCONA C 1.6 - 1.8 ASTRA CALIBRA KADETT D KADETT E 1.6 - Diesel
4540030	
90112609	ØF _G -59 ØF _P -21 A-95

FOLE DO SEMI-EIXO DIFERENCIAL LADO DA RODA	
	ASTRA 1.8 - 2.0 - D ASCONA C 1.6 - 1.8 - DIESEL KADETT D 1.3 - 1.6 - 1.8 KADETT D DIESEL KADETT E VECTRA 1.8 - 2.0 - D - TD
4560045	
60562336	ØF _G -83 ØF _P -22 A-84

JOGO DE PALAS OPEL CORSA APÓS 93	
	
4540052	
	C-335 L-200

JOGO DE PALAS OPEL CORSA ANTES 93	
	
4540053	
	C-410 L-217

SILENT-BLOC DO ESTICADOR DA SUSPENSÃO	
	CORSA
4540003	
353560	ØE-32.4 ØE _A -42 ØE _A -46 ØF-14 A-36.2

SILENT-BLOC DO BRAÇO DA SUSPENSÃO	
	CORSA
4540004	
	ØE-34 ØE _A -42 ØF-10 A-52

SILENT-BLOC DA SUSPENSÃO	
	CORSA B
4540012	
0352301	ØE-38 ØE _A -45 ØF-10 A-52



SILENT-BLOC DO BRAÇO DE SUSPENSÃO ANTERIOR	
	ASTRA 1.4 - 1.6 - 1.8 - 2.0 ASTRA 1.7D ASTRA 1.7TD
4540013	
0352300 0352346	ØE-38 ØEA-43 ØF-12 A-59.5

SILENT-BLOC EXTERIOR DO BRAÇO SUSPENSÃO ANTERIOR	
	ASTRA 1.4 - 1.6 - 1.8 - 2.0 ASTRA 1.7D - 1.7TD CALIBRA VECTRA
4540014	
352317 352348	ØE-60 ØEA-67 ØF-16 A-58

SILENT-BLOC ANTERIOR DO BRAÇO SUSPENSÃO ANTERIOR	
	KADETT D KADETT E
4540037	
352334 352349	ØE-39.5 ØEA-44.5 ØF-14 A-59

TUBO INFERIOR DE SAÍDA DE ÁGUA DO RADIADOR	
	ASTRA D
4540025	
1337111	ØFG-38 ØFP-33

TUBO INFERIOR DE SAÍDA DE ÁGUA DO RADIADOR	
	CORSA A 1.2 CORSA A 1.3
4540031	
901128699 1336323	ØF-35 ØF-35

TUBO INFERIOR DE SAÍDA DA ÁGUA DO RADIADOR	
	ASTRA 1.8
4540033	
1337110	ØFG-40 ØFP-34

TUBO SUPERIOR DE ENTRADA DE ÁGUA DO RADIADOR	
	CORSA A 1.3 CORSA A 1.4
4540034	
90264448 1336431	ØFG-40 ØFP-33

TUBO SUPERIOR DE ENTRADA DE ÁGUA DO RADIADOR	
	CORSA A 1.2
4540045	
1336320 90128695	ØF-34 ØF-34



TUBO SUPERIOR DE ENTRADA DE ÁGUA DO RADIADOR	
	ASTRA TD
4540046	
1337107	ØF-32 ØF-32

TUBO SUPERIOR DE ENTRADA DE ÁGUA DO RADIADOR	
	ASTRA D
4540047	
1337106	ØF-34 ØF-34

TUBO INFERIOR DE SAÍDA DE ÁGUA DO RADIADOR	
	CORSA B 1.2 - 1.4
4540049	
1337193	ØF-39 ØF-34

TUBO SUPERIOR DE ENTRADA DE ÁGUA DO RADIADOR	
	ASTRA 1.4 - 1.6
4540050	
1337133	ØF-44 ØF-34

APOIO INTERMÉDIO DA SUSPENSÃO ANTERIOR	
	205 309 1.3 309 1.4 309 1.6
4510006	
1844.16	∅F-10 A-31 C-88 L-40

APOIO POSTERIOR DO MOTOR	
	J5
4510008	
1843.61	∅F-12 L-73

SUPORTE ANTERIOR DIREITO DO MOTOR	
	106 motorização XU e XUD 205 D motorização XU e XUD 305 motorização XU e XUD 306 1.6 - 1.8 309 1.6 motorização XU e XUD 309 D motorização XU e XUD 309 TD motorização XU e XUD 405 motorização XU e XUD
4510012	
1843.73 1844.37	∅P-10 A _P -32 A _P -22 ∅E-81.5 A-79

SUPORTE HIDRAULICO ANTERIOR DIREITO DO MOTOR	
	106 motorização XU e XUD 205 D motorização XU e XUD 305 motorização XU e XUD 306 1.6 - 1.8 309 1.6 motorização XU e XUD 309 D motorização XU e XUD 309 TD motorização XU e XUD 405 motorização XU e XUD
4510012.1	
1843.73 1844.37	∅P-10 A _P -32 A _P -22 ∅E-81.5 A-79

APOIO ANTERIOR DO MOTOR	
	J5
4520065	
7550024 7601889	∅F-10.5 ∅P-12 A _P -31 A-79

APOIO POSTERIOR DO MOTOR	
	J5
4520066	
5934176	∅P-12 A _P -26 ∅F-10.5 A-88.5 C-149 L-57

APOIO DE MOTOR LADO DA CAIXA DE VELOCIDADES - Após viatura 0341865	
	J5
4520098	
	∅F-2x11 ∅P-12 A _P -25 A-102 C-148 L-57.5

APOIO DE MOTOR	
	504 D
4580007	
1807.28	∅P-10 A _P -24.5 ∅F-2x8.5 A-36.5 C-80.5 L-106

APOIO ANTERIOR ESQUERDO DO MOTOR	
	106 205 motorização XU 305 1.6 motorização XU 306 309 405
4580010	
1843.95	∅F-12.5 A-43 C-100.5 L-70

APOIO ANTERIOR DIREITO DO MOTOR	
	205 até 89
4580011	
1843.88	∅P-2x10 A _P -26 A _P -18 A-61 C-88 L-40.5

APOIO ANTERIOR DO MOTOR	
	404 504 505 Gas.
4580012	
1807.25	∅P-10 A _P -32 A-41 C-106 L-70

APOIO ANTERIOR DA TRAVESSA POSTERIOR	
	504 505
4580013	
5152.18 5152.42 5152.53	∅P-10 A _P -22.5 ∅P-2x8 A _P -2x18 A-39 C-76 L-40

APOIO ESQUERDO DA TRAVESSA POSTERIOR	
	504
4580014	
5152.16 5152.40	∅P-2x7 A _P -2x14 ∅P-10 A _P -22 A-43.5 C-70.5 L-54.5

APOIO DIREITO DA TRAVESSA POSTERIOR	
	504
4580015	
5152.17 5152.41	∅P-2x7 A _P -2x14 ∅P-10 A _P -22 A-43.5 C-70.5 L-54.5

APOIO POSTERIOR DO MOTOR	
	J5
4580057	
	∅F-14.5 ∅F-2x10.5 ∅F _R -2x10 A-111 L-73.5

SUPORTE ANTERIOR DA SUSPENSÃO ANTERIOR	
	205 309 405
4580058	
1844.17	∅P-8 A _P -26.5 A-26 C-49.5 L-44

APOIO ANTERIOR DIREITO DO MOTOR	
	106 954cc 106 1124cc
4580063	
1843.99	A _P -2x20.5 ØF-10.5 ØP-2x8 A-56 C- 126 L-70

APOIO ANTERIOR DO MOTOR	
	306 D - TD 406 1.6 · 1.8 · 1.8 16V · 2.0 16V 406 1.9 TD PARTNER 1.8D · 1.9D
4580090	
184447	ØP-2x10 A _P -33 A _P -23.5 A-78.5 ØE-94

BATENTE DA BARRA ESTABILIZADORA	
	106
4510030	
	ØF-19 C-34 L-24

BATENTE CENTRAL DA BARRA ESTABILIZADORA	
	106 954 106 1124
4510033	
5094.57	ØF-18.5 A-42 C-56 L-41

BATENTE DA BARRA ESTABILIZADORA ANTERIOR - BRANCA	
	205 GTI 309
4580030	
5094.36	ØF-20 A-32 C-55.5 L-39

BATENTE DA BARRA ESTABILIZADORA ANTERIOR - VERDE	
	205 Gas. exepo GTI 309
4580031	
5094.37	ØF-20 A-32.5 C-55 L-39.5

BATENTE DA BARRA ESTABILIZADORA ANTERIOR - AZUL	
	205 D 205 TD 309
4580032	
5094.40	ØF-23 A-32 C-55.5 L-39

BATENTE EM NYLON DA BARRA ESTABILIZADORA	
	104
4580035	
	ØF-20.5 A-39 C-43 L-42.5

BATENTE DA BARRA ESTABILIZADORA	
	504 505
4580059	
5094.09	∅F-25 A-24 C-44.5 L-45

BATENTE CENTRAL DA BARRA ESTABILIZADORA ANTERIOR	
	106 954 - 1124
4580083	
5094.60	∅F-21 A-33 C-73 L-34

CASQUILHO DO BRAÇO DE SUSPENSÃO ANTERIOR	
	404 504 505 604
4580001	
3523.10	∅E-24 ∅E _A -29.5 ∅F-16 A-17

CASQUILHO DA BARRA ESTABILIZADORA	
	TODOS
4580061	
	∅E-30 ∅F-10 A-20

CAPA DE PEDAL DO TRAVÃO E EMBRAIAGEM	
	405 605
4510017	
	C-103 L-68.5

CAPA DE PEDAL DO TRAVÃO	
	505
4580041	
4501.72	A-12.5 C-83 L-58

CAPA DE PEDAL DA EMBRAIAGEM	
	505
4580042	
2130.12	A-13 C-82.5 L-57.5

CAPA DE PEDAL DO TRAVÃO	
	205 309
4580043	
4504.07	A-14.5 C-57.5 L-53



CAPA DE PEDAL DA EMBRAIAGEM	
	205 309
4580044	
2130.10	A-14.5 C-57.5 L-53

CAPA DE PEDAL DA EMBRAIAGEM	
	306 405 605 806
4580045	
2130.13	A-12.5 C-84.5 L-57

CAPA DE PEDAL DO TRAVÃO	
	306 405 605 806
4580046	
4504.12	A-12.5 C-84 L-57.5

SUPORTE DO FILTRO DE AR	
	204 304 305
4530002	
0356.04	ØP-2x6 Ap-14.5 A-25 C-27.5 L-24.5

CARDAN DA DIRECÇÃO	
	104 106 204 304 305 306 504 505 604
4580016	
4040.15 4040.18 4040.20 4040.22	ØE-75 ØF-4x8 A-11.5

ABRAÇADEIRA DA BARRA ESTABILIZADORA	
	104
4580037	
	ØF-2x11 A-36 C-53 L-77

ABRAÇADEIRA DA BARRA ESTABILIZADORA	
	205 309
4580038	
5097.27	ØP-2x10 Ap-27 A-27.5 C-72.5 L-54.5

KIT DE REPARAÇÃO DA DIRECÇÃO	
	TODOS
4580040	1 x CASQUILHO ØE-34 ØF-24 A-14.5 2 x ANILHA BORRACHA ØE-32.5 ØF-26 A-6.5 2 x ANILHA METÁLICA ØE-34 ØF-27 A-1.5 1 x FREIO DE TUBO ØE-36.5 A-1.5
4006.14	

SUPORTE DO FILTRO DE AR	
	205 504 505 604
4580062	
1439.10	∅P-2x6 A _P -2x10 A-20.5 C-32 L-23

ESTICADOR POSTERIOR DO ESCAPE	
	106 1360 IE 205 309 405 J9
4510001	
1755.44	A-24.75 C-64.5 L-45

ESTICADOR DE ESCAPE	
	405 604
4510019	
1755.55	A-37 C-70.5 L-45.5

SUPORTE DO TUBO DE ESCAPE	
	106 1360 IE 205 309 405 J9
4510052	
1755.44	∅F-2x9 A-45 C-44 L-44

ESTICADOR DE ESCAPE	
	J5 D desde 81
4520051	
1754.47	∅F-6.5 A-33.5 C-79.5 L-36

ANEL DE ESCAPE	
	J5
4545023	
1755.38	∅E-63 A-15

SUPORTE POSTERIOR DO ESCAPE	
	106 1360 IE 205 309 (Suporte anterior) 405 (Suporte anterior) J9
4580008	
1755.44	A-39.5 C-65 L-45

SUPORTE ANTERIOR DO TUBO DE ESCAPE	
	106
4580085	
1755.56	A-16 C-67.5 L-45



FOLE DO SEMI-EIXO DIFERENCIAL LADO DA CAIXA DE VELOCIDADES	
	106 1.0 106 1.1 205
4510014	
3287.75	ØF _G -63 ØF _P -20 A-155

FOLE ESQUERDO DO SEMI-EIXO DIFERENCIAL LADO DA CAIXA DE VELOCIDADES	
	J5 PETROL
4510032	
3287.49	ØF _G -94 ØF _P -24 A-103

FOLE DO SEMI-EIXO DIFERENCIAL LADO DA RODA	
	106 205 1.0 desde 89 205 1.1 desde 89 205 1.4 desde 89
4510036	
3293.81	ØF _G -73 ØF _P -19 A-82

FOLE DIREITO E ESQUERDO DA DIRECÇÃO	
	405 com direcção assistida
4510044	
	ØF _G -47 ØF _P -11 A-200

FOLE DO SEMI-EIXO LADO DA CAIXA DE VELOCIDADES	
	205 exepo GT - GTI - D 205 até 12/85 306 1.8 XU 309 GRI - GTI 405 1.6 GR - 1.6 SR 605
4510047	
3293.59	ØF _G -75 ØF _P -22 A-100

FOLE DO SEMI-EIXO DIFERENCIAL LADO DA RODA	
	J5
4510048	
3293.42	ØF _G -95 ØF _P -24 A-150

FOLE DO SEMI-EIXO DIFERENCIAL LADO DA CAIXA DE VELOCIDADES	
	106 205 306 309 405
4510049	
3287.69	ØF _G -70 ØF _P -20 A-170

FOLE DO SEMI-EIXO DIFERENCIAL LADO DA RODA	
	305 1.6 após 83 305 D após 83 309 1.4 até 88 309 1.6 até 88
4510053	
3208.40 3293.51	ØF _G -77 ØF _P -22 A-79



FOLE ESQUERDO E DIREITO DA DIRECÇÃO	
	504 só direito 505 604 só direito
4510063	
4066.17	ØF _G -43 ØF _P -43 A-118

FOLE DO SEMI-EIXO DIFERENCIAL LADO DA RODA	
	J5
4520037	
3293.42	ØF _G -92 ØF _P -24 A-145

FOLE ESQUERDO DA DIRAECÇÃO	
	J5
4520073	
4066.19	ØF _G -49 ØF _P -11 A-155

FOLE DIREITO DA DIRECÇÃO	
	J5
4520081	
4066.18	ØF _G -38 ØF _P -11.5 A-215

FOLE DO SEMI-EIXO DIFERENCIAL LADO DA RODA	
	104 até 80 205 954cc após 83 205 1118cc após 83 205 1360cc após 83
4530020	
3293.40	ØF _G -68 ØF _P -17 A-100

FOLE DO SEMI-EIXO DIFERENCIAL LADO DA RODA	
	104 após 81 204 304 205 954 - 1118 - 1360 305 309 1.1
4530169	
3293.31 3293.41 3293.74	ØF _G -78 ØF _P -20 A-116

FOLE DA CAIXA DA DIRECÇÃO ASSISTIDA	
	205 306 309
4565005	
4066.22	ØF _G -43 ØF _P -40 A-140

FOLE DO SEMI.EIXO DIFERENCIAL LADO DA RODA	
	205 GTI 205 RALLY 305 306 1.4 com motorização TU 306 1.6 com motorização TU 309 1.4 após 89 309 1.6 após 89
4580066	
3293.77	ØF _G -82 ØF _P -20 A-95



FOLE DIREITO E ESQUERDO DA DIRECÇÃO	
	104 após 79 204 após 79 205 304 após 79 305 306 309 504 505 604
4580067	
4066.15 4066.20	∅F _G -40 ∅F _P -10 A-175

FOLE DIREITO DA DIRECÇÃO	
	405 com direcção assistida
4580068	
4066.16	∅F _G -39 ∅F _P -11 A-66

FOLE DO SEMI-EIXO DIFERENCIAL LADO DA RODA	
	306 1.8 com motorização XU 306 D com motorização XU 405 1.4
4580070	
3293.83	∅F _G -82 ∅F _P -20 A-105

FOLE DIREITO DA DIRECÇÃO	
	504 até 7/79
4580077	
4066.08	∅F _G -58 ∅F _P -34 A-130

FOLE DO SEMI-EIXO DIFERENCIAL LADO DA RODA	
	106 205 GTI · RALLY 305 306 1.4 viaturas com motorização TU 306 1.6 viaturas com motorização TU 309 1.4 após 89 309 1.6 após 89
4580079	
3293.77	∅F _G -82 ∅F _P -19 A-85

SIELNT-BLOC DO APOIO INFERIOR DA SUSPENSÃO ANTERIOR	
	205 com motorização XU e XUD 305 com motorização XU e XUD 306 com motorização XU e XUD 309 com motorização XU e XUD 405 com motorização XU e XUD 405 D · TD
4510007	
1809.16	∅E-70 ∅F-10 A _E -40 A-53

SILENT-BLOC DO APOIO 4510008	
	J5
4510009	
	∅E-70 ∅F-12 A _E -50 A-64

SILENT-BLOC DA SUSPENSÃO DO MOTOR	
	106 205 305 306 1.4 · 1.6 309 405
4510055	
1809.04	∅E-30 ∅F-12 A _E -28 A-34



SILENT-BLOC POSTERIOR DO MOTOR	
	605
4510064	
1809.22	ØE-30 ØF-10 A _E -28 A _I -50

SILENT-BLOC DA SUSPENSÃO POSTERIOR	
	404 Caixa Aberta 504 BREAK
4580002	
5131.04 5131.07	ØE-32 ØF-16 A _E -50 A _I -54

SILENT-BLOC ANTERIOR DO BRAÇO DE SUSPENSÃO ANTERIOR	
	404
4580003	
3561.04	ØE-32 ØE _A -43 ØF-12 A-50

SILENT-BLOC DO BRAÇO ANTERIOR DA SUSPENSÃO ANTERIOR	
	404
4580004	
3523.09 3523.37	ØE-28 ØF-12 A _E -32 A _I -38

SILENT-BLOC DO BRAÇO SUSPENSÃO ANTERIOR	
	504 505 604
4580005	
3561.06	ØE-37.5 ØE _A -50 ØF-16 A-41.5

SILENT-BLOC DO BRAÇO POSTERIOR DA SUSPENSÃO ANTERIOR	
	504
4580006	
3523.12 3523.36	ØE-29 ØF-14 A _E -32 A _I -44

SILENT-BLOC DO BRAÇO SUSPENSÃO ANTERIOR	
	205 exepcto GTI
4580022	
3523.25 3523.29 3523.27 3523.49	ØE-36 ØE _A -48 ØF-12 A-25

SILENT-BLOC DO BRAÇO SUSPENSÃO ANTERIOR	
	104 104 ZS 104 GLS 205
4580023	
3523.20	ØE-28 ØF-10 A _E -28 A _I -38



SILENT-BLOC CENTRAL DO BRAÇO SUSPENSÃO ANTERIOR	
	205 309 excepto GTI e GT
4580024	
3523.35	ØE-36 ØEA-51.5 ØF-12 A-25

SILENT-BLOC DO BRAÇO SUSPENSÃO POSTERIOR	
	204 304 305
4580025	
3523.17	ØE-31 ØEA-43 ØF-12 A-38

SILENT-BLOC CENTRAL DO BRAÇO SUSPENSÃO ANTERIOR	
	405
4580026	
3523.40	ØE-33 ØEA-42 ØF-12 A-38

SILENT-BLOC DO BRAÇO SUSPENSÃO ANTERIOR	
	104 104 ZS 104 GLS 205 excepto GTI
4580027	
3523.20	ØE-28 ØF-10 A _E -28 A _r -34

SILENT-BLOC DO BRAÇO SUSPENSÃO ANTERIOR	
	104
4580028	
3523.14	ØE-38 ØF-14 A _E -24 A _r -42

SILENT-BLOC DA ARTICULAÇÃO ELÁSTICA	
	104
4580029	
3523.13	ØE-27 ØF-10 A _E -28 A _r -34

SILENT-BLOC ANTERIOR DO BRAÇO SUSPENSÃO POSTERIOR	
	504 505 604
4580034	
3523.16	ØE-33 ØF-14 A _E -32 A _r -44

SILENT-BLOC DO BRAÇO DE SUSPENSÃO ANTERIOR	
	504 505 604
4580036	
3561.06 3561.11 3561.09	ØE-37.5 ØEA-50 ØF-16 A-41.5

SILENT-BLOC CENTRAL DO BRAÇO DA SUSPENSÃO ANTERIOR	
	106
4580049	
3523.50	ØE-34 ØF-12 A _E -30 A _I -48.5

SILENT-BLOC DA SUSPENSÃO POSTERIOR	
	106 com motorização TU3J2
4580050	
3523.51	ØP-2x10 A _P -28 ØF-17 A-47 C-86.5 L-55

SILENT-BLOC DO BRAÇO DE SUSPENSÃO ANTERIOR	
	205 GTI 306 309
4580056	
3523.31	ØE-28 ØE _A -38 ØF-10 A-34

SILENT-BLOC DE MOLAS	
	
4580060	
	ØE-32 ØF-16 A _E -60 A _I -69

SILENT-BLOC INFERIOR DA SUSPENSÃO DO MOTOR	
	106 205 305 com motorização XU e XUD 306 1.4 - 1.6 309 com motorização XU e XU 405
4580064	
1809.04	ØE-30 ØF-12 A _E -28 A _I -34

TUBO SUPERIOR DE ENTRADA DE ÁGUA DO RADIADOR - VIATURAS COM RADIADOR METÁLICO	
	205 954 - 1124 - 1360 após 89
4550010	
1343.96	ØF-30 ØF-30

TUBO INFERIOR DE SAÍDA DE ÁGUA DO RADIADOR	
	205 954cc 205 1124cc
4580065	
1350.83	ØF-30 ØF-30

TUBO INFERIOR DE SAÍDA DE ÁGUA DO RADIADOR	
	404 D após 71 504 2.1D
4580069	
1350.38	ØF _G -40 ØF _P -35

TUBO INFERIOR DE SAÍDA DE ÁGUA DO RADIADOR	
	309 1.4 309 1.6
4580071	
1307.63	ØF-32 ØF-32

TUBO INFERIOR DE SAÍDA DE ÁGUA DO RADIADOR	
	309 D 309 TD
4580072	
1351.21	ØF-31 ØF-31

TUBO SUPERIOR DE ENTRADA DE ÁGUA DO RADIADOR	
	504 2.1D
4580073	
1343.29	ØF _G -54 ØF _P -44

TUBO SUPERIOR DE ENTRADA DE ÁGUA DO RADIADOR	
	504 2.3D 505 D
4580074	
1343.36	ØF _G -50 ØF _P -37

TUBO INFERIOR DE SAÍDA DE ÁGUA DO RADIADOR	
	504 2.3D 505 D
4580075	
1350.46	ØF _G -39 ØF _P -32

TUBO SUPERIOR DE ENTRADA DE ÁGUA DO RADIADOR	
	309 D
4580076	
1343.82	ØF _G -34 ØF _P -31

TUBO INFERIOR DE SAÍDA DE ÁGUA DO RADIADOR	
	106 sem ar condicionado
4580080	
1343.60	ØF-30 ØF-30

TUBO INFERIOR DE SAÍDA DE ÁGUA DO RADIADOR	
	309 D 309 TD
4580081	
1351.21	ØF-31 ØF-31

TUBO INFERIOR DE SAÍDA DE ÁGUA DO RADIADOR	
	205 1118 - 1124 - 1294 - 1360
4580082	
1317.25	ØF-32 ØF-32

TUBO INFERIOR DE SAÍDA DE ÁGUA DO RADIADOR	
	504 2.3D 505 D
4580084	
1350.46	ØF _G -37 ØF _P -34

TUBO SUPERIOR DE ENTRADA DE ÁGUA DO RADIADOR	
	205 954 - 1124
4580086	
1343.66	ØF _G -35.5 ØF _P -30

TUBO SUPERIOR DE ENTRADA DE ÁGUA DO RADIADOR	
	205 954 - 1124
4580087	
1343.66	ØF-34 ØF-29

TUBO INFERIOR DE SAÍDA DE ÁGUA DO RADIADOR	
	309 1.1 - 1.3
4580088	
1317.27	ØF-30 ØF-30



FOLE DIREITO DA DIRECÇÃO	
	125 P
4520040	
SE138162132A 4239459 4371156	ØF _G -26 ØF _P -10 A-165

FOLE ESQUERDO DA DIRECÇÃO	
	125 P
4520063	
SE138162131A 4239458 4371155	ØF _G -42 ØF _P -10 A-125



SUPORTE DA CAIXA DE VELOCIDADES	
	R12 R18
4530007	
7700575465 8300608	ØP-6 A _P -12 A-18.5 C-32 L-22

SUPORTE POSTERIOR DA CAIXA DE VELOCIDADES	
	R4 R6
4530009	
7700546313 7702006764	ØP-8 A _P -13.5 A-30 C-126 L-96

SUPORTE DA CAIXA DE VELOCIDADES	
	R5
4530010	
7700533443 7700533444	ØF-4x9 ØF-2x8.5 A-63 C-134 L-127

APOIO ANTERIOR ESQUERDO DO MOTOR	
	SUPER 5 R9 R11 R21 TS R21 GTS R21 TSE EXPRESS
4530024	
7700763207 7704001320	ØP-10 A _P -27 A-62 C-111 L-51

APOIO ANTERIOR DIREITO DO MOTOR	
	SUPER 5 Gas. R9 R11 R21 TS R21 GTS R21 TSE EXPRESS Gas.
4530025	
7700762721 7700763206 7704001319	ØP-10 A _P -26 ØF-2x10 A-66.5 C-124 L-56

APOIO CENTRAL DO MOTOR	
	SUPER 5 Gas. R9 R11 R21 TS - GTS - TSE EXPRESS Gas.
4530030	
7700760488 7700760510 7700765935 7704001317	ØP-10 A _P -30 ØF-10 C-145 L-62

APOIO CENTRAL DO MOTOR	
	R5 SUPER 5 R18 GTX
4530033	
7700692341 7701349504	ØF-6x9 A-49.5 C-182 L-163

APOIO CENTRAL DO MOTOR	
	R18 D R18 GTX ESPACE FUEGO
4530035	
7704000829	ØP-2x8 A _P -2x22.5 ØF-10 A-75 C-50.5 L-54



APOIO ANTERIOR ESQUERDO DO MOTOR



R4 GTL
R5
R6 1.1 TL

4530038

7700527555 7700527557
7700527603

ØP-8 A_P-23 ØF-3x9
ØF-11 L-98.5

APOIO ANTERIOR DIREITO DO MOTOR



R4 GTL
R5
R6 1.1 TL

4530039

7700528173 7700556353
7700674446

ØP-8 A_P-23
A-92.5 L-99

APOIO ANTERIOR DO MOTOR



R12

4530040

7700504590

ØP-10 A_P-19.5
A-47 C-79 L-129

SUPORTE DO BRAÇO OSCILANTE



R4
R5
R6

4530051

8243734 8558634
7700500113 7702108305

ØF-12 ØF-2x7
A-34 C-73 L-49

APOIO ANTERIOR ESQUERDO DO MOTOR



SUPER 5 D
EXPRESS D

4530053

7700770307

ØP-10 A_P-69.5 ØP-2x8
C-53 L-41 A_P-2x21

APOIO ANTERIOR DIREITO DO MOTOR



SUPER 5 D
EXPRESS D

4530059

7700770480

ØP-2x10 A_P-2x23.5
ØP-10 A_P-31 C-109 L-60.5

APOIO POSTERIOR DO MOTOR



R21 D
R21 TXE

4530060

7700766126

ØP-2x10 A_P-35 A_P-38.5
A-84 C-75 L-65

APOIO ANTERIOR ESQUERDO DO MOTOR



SUPER 5 D
EXPRESS D

4530064

7700770479

ØF-12 ØF_R-10
A-118 C-133 L-64.5

APOIO ANTERIOR ESQUERDO DO MOTOR	
	R19 exepo DIESEL CLIO
4530073	
7700801543	ØP-2x10 A _P -26.5 A _P -31 A-71.5 C-101 L-61

SUPORTE POSTERIOR CENTRAL DO MOTOR	
	R19 exepo DIESEL CLIO
4530074	
7700804163	ØF-12 A-120.5 L-155

APOIO ANTERIOR ESQUERDO DO MOTOR	
	SUPER 5 Gas. R9 R11 R21 EXPRESS Gas.
4530087	
7700755531	ØP-10 A _P -29 ØF-2x11 A-94 C-113.5 L-52

SUPORTE DE MOTOR	
	LAGUNA
4530092	
7700818371	ØF-12.5 ØF-2x13 A-40.5 C-161 L-89

SUPORTE ANTERIOR ESQUERDO DO MOTOR	
	R21 TD R21 GTD R21 TXE
4530096	
7700769719	ØP-2x10 A _P -35/38 ØF-24 A-69.5 C-118 L-97

SUPORTE ANTERIOR DIREITO DO MOTOR	
	R21 TD R21 GTD R21 TXE
4530097	
7700769720	ØP-2x10 A _P -2x35 ØF-23 A-62 C-124 L-88

SUPORTE ANTERIOR DIREITO DO MOTOR	
	R19 exepo DIESEL CLIO
4530098	
7700785949	ØP-2x10 A _P -2x28 ØP-10 A _P -29.5 C-113 L-84

SUPORTE ANTERIOR DIREITO DO MOTOR	
	R19 TD
4530113	
7700788383 7700802927	ØP-10 A _P -29 A-84.5 L-92



SUPORTE ANTERIOR DIREITO DO MOTOR HIDRAULICO	
	R19 TD
4530114	
7700788383 7700802927	ØP-10 A _P -29 A-84.5 L-92

SUPORTE POSTERIOR DO MOTOR	
	CLIO 1.2 CLIO 1.4 CLIO D
4530125	
7700800522	ØF-2x10 A-46 C-161 L-66.5

SUPORTE ANTERIOR DIREITO DO MOTOR	
	CLIO 1.2 CLIO 1.4 CLIO 1.8 CLIO D
4530127	
7700805123	ØF-4x18.5 ØP-10 A _P -29 A-111 C-130 L-172.5

APOIO HIDRÁULICO DIREITO DO MOTOR	
	LAGUNA
4530128	
7700423007E	ØF-14.5 A-138

SUPORTE DA CAIXA DE VELOCIDADES	
	TRAFIC
4530130	
7700702890	ØF-12 A-60.5 C-130 L-82

SUPORTE ANTERIOR ESQUERDO DO MOTOR	
	R19 TD
4530137	
7700788318	ØF-12 A-47.5 C-123 L-71

SUPORTE ANTERIOR ESQUERDO DO MOTOR	
	CLIO 1.2 CLIO 1.4 CLIO 1.8 CLIO D
4530146	
7700795689	ØP-2x8 A _P -2x27 ØF-12 A-37 C-138 L-102

APOIO POSTERIOR DO MOTOR	
	CLIO II exepto D KANGOO 1.2 - D MEGANE 1.4 16V - 1.6 16V - TD
4530172	
7700832264	ØF-2x10 A-46 C-165 L-55

APOIO ANTERIOR DO MOTOR	
	CLIO II exepcto 1.2 e DTI KANGOO 1.4 · D
4530176	
7700434370	ØP-10 A-34 A-109 C-170 L-117

APOIO ANTERIOR DO MOTOR	
	CLIO II KANGOO 1.2
4530179	
7700415087	ØF-2x18.5 ØF-2x12 ØF-13 A-79 C-172 L-99.5

APOIO POSTERIOR DO MOTOR	
	KANGOO D
4530181	
7700800522	ØF-2x10 A-46 C-164 L-68

APOIO DE ESCAPE	
	CLIO II
4530191	
	A-84 C-217 L-96

BATENTE DAS EXTREMIDADES DA BARRA ESTABILIZADORA	
	SUPER 5 R19 R21 CLIO
4530031	
	ØF-21 A-47 C-57 L-41.5

BATENTE CENTRAL DA BARRA ESTABILIZADORA	
	SUPER 5 2ª Série R9 R11 R21 TS · GTS · TSE EXPRESS
4530032	
7702111932	ØF-22 A-41 C-41 L-34

BATENTE LATERAL DA BARRA ESTABILIZADORA POSTERIOR	
	R4 R6
4530046	
7702106144	ØF-10 ØF-11 A-29 C-76.5 L-38.5

BATENTE LATERAL DA BARRA ESTABILIZADORA POSTERIOR	
	R4 R5 R6
4530047	
7700687374 7702003408	ØF-12 ØF-10.5 A-33 C-71.5 L-38



BATENTE LATERAL DA BARRA ESTABILIZADORA POSTERIOR	
	R5
4530048	
7702107985	ØF-10 ØF-11 A-51 C-76.5 L-38.5

BATENTE LATERAL DA BARRA ESTABILIZADORA POSTERIOR	
	R5
4530049	
7702106143	ØF-10 ØF-8 A-29 C-73 L-38

BATENTE LATERAL DA BARRA ESTABILIZADORA POSTERIOR	
	R5
4530050	
7702107984	ØF-10 ØF-8 A-51 C-73 L-38

BATENTE LATERAL DA BARRA ESTABILIZADORA ANTERIOR	
	R19 R21 TD R21 TXE
4530067	
7700771562	ØF-21 A-34 C-68.5 L-46

BATENTE CENTRAL DA BARRA ESTABILIZADORA ANTERIOR	
	R21 TD R21 TXE
4530068	
7700769226	ØF-22 A-46.5 C-46 L-34

BATENTE CENTRAL DA BARRA ESTABILIZADORA ANTERIOR	
	R19 CLIO
4530075	
7700785788	ØF-21 A-47 C-42 L-36

BATENTE CENTRAL DA BARRA ESTABILIZADORA	
	CLIO
4530076	
7700798053	ØF-21 A-47 C-42 L-35.5

BATENTE LATERAL DA BARRA ESTABILIZADORA ANTERIOR	
	R9 R11 R21 TS R21 GTS R21 TSE
4530078	
7700760264	ØF-22 A-47 C-54.5 L-41



BATENTE CENTRAL DA BARRA ESTABILIZADORA ANTERIOR	
	R5 R9 R11 EXPRESS
4530079	
7700763934 7702144561	ØF-21 A-41 C-41.5 L-33.5

BATENTE LATERAL DA BARRA ESTABILIZADORA ANTERIOR	
	SUPER 5 EXPRESS
4530080	
7700760265	ØF-21 A-47 C-54.5 L-41

BATENTE DA BARRA ESTABILIZADORA	
	TRAFIC
4530100	
7700001091	ØF-12 ØF-21 A-37 C-91.5 L-56

BATENTE CENTRAL DA BARRA ESTABILIZADORA	
	TRAFIC
4530101	
7700667186	ØF-25 A-37.5 C-41.5 L-24

BATENTE DA BARRA ESTABILIZADORA	
	R21
4530102	
7700774026	ØF-24 A-46 C-70 L-54

BATENTE DA EXTREMIDADE DA BARRA ESTABILIZADORA	
	R19
4530112	
7700784170A	ØF-20 A-46.5 C-60 L-41.5

BATENTE CENTRAL DA BARRA ESTABILIZADORA ANTERIOR	
	R5 SUPER 5 1ª Série R9 R11 EXPRESS
4530118	
7700763934	ØF-20 A-34.5 C-40 L-35.5

BATENTE DA BARRA ESTABILIZADORA	
	R4 R5 R6
4530129	
6082687	ØF-16 A-30 C-31.5 L-22



CASQUILHO DO TIRANTE DA ARTICULAÇÃO



R12

4530021

7700547187

ØE-38 ØF-13.8
A_E-16.7

CASQUILHO INFERIOR DA DIRECÇÃO



R5
R6
R12

4530043

7702105447

ØE-36.5 ØF-18
A-20

CASQUILHO INFERIOR DA DIRECÇÃO



R12 BREAK

4530044

7700519176

ØE-36.5 ØF-18.5
A-15

CASQUILHO SUPERIOR DA DIRECÇÃO



R4
R5
R6
R12

4530045

855590000

ØE-36.5 ØF-18.5
A-19.5

CASQUILHO DA EXTREMIDADE DA CREMALHEIRA DA DIRECÇÃO



R5 desde 85
R9
R11
R19
R21
CLIO
EXPRESS

4530089

7704000926

ØF-20
A-18 C-29.5 L-29

CASQUILHO DE MOLAS POSTERIOR



TRAFIC

4530120

ØE-33 ØE_A-37.5 ØF-17.5
A-48

CAPA DE PEDAL DO TRAVÃO E EMBRAIAGEM



R5 L
R5 TL
R5 GTL
R5 LS
R5 TS
R6

4530088

7700569868

C-65 L-43

CAPA DE PEDAL DO TRAVÃO E EMBRAIAGEM



SUPER 5
R9
R11
R19
CLIO
SPACE
EXPRESS

4530090

7700680836

C-60 L-49.5

CAPA DE PEDAL DO TRAVÃO E EMBRAIAGEM	
	R21 R25
4530095	
7700765318	C-73 L-58

CAPA DE PEDAL DO TRAVÃO E EMBRAIAGEM	
	CLIO II KANGOO
4530186	
7700416724	A-10 C-76 L-51

JUNTA CARDAN DA DIRECÇÃO	
	R4 R5 R6 R9 R11 R12 R14 R15 R16 R17 R18 R20 FUEGO
4530001	
7700549015 7704002058	ØE-74.5 ØF-4x8.5 A-12

JUNTA CARDAN DA DIRECÇÃO	
	R4 R5 R6 R12 R16 R18 R20 FUEGO
4530011	
7700509257 7701348067 7704001919	ØF-2x9 A-32 C-50 L-32

JUNTA CARDAN DA DIRECÇÃO	
	SUPER 5 R9 R11 R21 R25 CLIO EXPRESS
4530029	
7700687433 7701349339	ØF-2x8 A-32 C-44 L-32

ESTICADOR DA BARRA ESTABILIZADORA	
	R12 R18 até 81
4530052	
7700540384 7701453465	ØF-14 ØP-10 A-47 C-180 L-42.5

KIT DE REPARAÇÃO DA DIRECÇÃO	
	R4 R5 R6
4530061	1 x CASQUILHO ØE-30 ØF-19.5 A-14 2 x ANILHA BORRACHA ØE-29 ØF-22 A-6 2 x ANILHA METÁLICA ØE-30 ØF-22 A-2 1 x FREIO DE TUBO ØE-32 A-1
7701455251	

ABRAÇADEIRA DA BARRA ESTABILIZADORA	
	R4 R6
4530081	
608132700	A-28 C-80 L-25.5

ABRAÇADEIRA DA BARRA ESTABILIZADORA



R21
NEVADA Gas.

4530082

7700757109

A-48 C-84.5 L-30

ABRAÇADEIRA DA BARRA ESTABILIZADORA



SUPER 5
R9
R11
R19
CLIO
EXPRESS

4530083

7700680098

A-28.5 C-79 L-25

ABRAÇADEIRA DA BARRA ESTABILIZADORA



SUPER 5
R9
R11
R19
CLIO
EXPRESS

4530084

7700680097

A-23 C-73 L-35

ABRAÇADEIRA DA BARRA ESTABILIZADORA



R21
NEVADA D

4530085

7700774027

A-42 C-98 L-31

ABRAÇADEIRA ESQUERDA OU DIREITA DA BARRA ESTABILIZADORA



R21
NEVADA

4530086

7700771569

7700771568

A-34.5 C-95 L-55

KIT DE REPARAÇÃO DA CAIXA DE VELOCIDADES



R19
CLIO

1xFOLE
ØF_o-27 ØF_f-16 A-16

2xFOLE
ØF_o-21 ØF_f-8.5 A-15.5

1xCASQUILHO PLÁSTICO
ØE-26 ØF-14.5 A-12

4530111

SILENT-BLOC DA BARRA ESTABILIZADORA



CLIO

4530115

7700799404

ØE-26.5
C-74

CREMALHEIRA DO PEDAL DE EMBRAIAGEM



SUPER 5
R9
R11
R19
CLIO
EXPRESS

4530148

770067921

L-29

SUPORTE DE ESCAPE	
	R4 R5 R6
4530002	
7700511170 7700558542 7701348802	ØP-2x6 A _P -14.5 A-25 C-27.5 L-24.5

SUPORTE DE ESCAPE	
	R4 R6 R12 R16 R18
4530003	
7700523095 8556492	ØP-2x10 A _P -17 A-27 C-46.5 L-41

SUPORTE DE ESCAPE	
	R6 R12 R15 R17 R18 R20 R21 R25 ESPACE FUEGO MASTER
4530004	
7700565762	ØP-2x8 A _P -2x20.5 A-27 C-46 L-41

ANEL DE ESCAPE	
	R12
4530005	
7700518504	ØE-55 ØF-36 A-9.5

SUPORTE DO TUBO DE ESCAPE	
	R18 R20 FUEGO TRAFIC
4530022	
7700655644 7704001364	ØE-64 ØF-2x7 A-23

SUPORTE DO TUBO DE ESCAPE	
	R5 R9 R11 R21 ESPACE EXPRESS
4530027	
7700677733 7700775183	ØF-2x8 A-27 C-53.5 L-33

SUPORTE POSTERIOR DO TUBO DE ESCAPE	
	SUPER 5 R9 R11 R21 ESPACE EXPRESS TRAFIC
4530028	
7700686449 7700677733	ØF-4x8.5 A-31 C-87.5 L-26.5

SUPORTE DO TUBO DE ESCAPE	
	R19 CLIO
4530069	
7700785798	ØF-10 A-50.5 C-46 L-28.5

ESTICADOR DE ESCAPE	
	R14 R18 R20 R25 R30 ESPACE FUEGO MASTER TRAFIC
4530077	
7700632015	∅E-64 A-12.5

SUPORTE POSTERIOR DO TUBO DE ESCAPE	
	SUPER 5 R21 CLIO EXPRESS
4530116	
7700779356	∅F-2x8.5 A-27 C-52 L-27.5

SUPORTE DE ESCAPE	
	SUPER 5 R14 R25
4530166	
7700647025 7700656895 7704002484	∅P-6 A _P -13 A-26 C-32 L-26

ESTICADOR INTERMÉDIO DO ESCAPE	
	CLIO II 1.4 16V · 1.6 · 1.6 16V
4530173	
7700424340	∅F-13 ∅F-8 A-52 C-73.5 L-45

ESTICADOR INTERMÉDIO DO ESCAPE	
	CLIO II 1.2 · 1.4 · D · DTI
4530175	
7700424341	∅F-13 ∅F-8 A-52 C-73.5 L-45

ESTICADOR ESCAPE	
	LAGUNA após 94 SAFRANE de 92 a 96
4530192	
7700828897	∅F-8 A-39.5 C-56 L-35

ESTICADOR ESCAPE	
	MEGANE de 95 a 97
4530193	
7700836095	∅F-10.5 A-51 C-47.5 L-28

FOLE DO SEMI-EIXO DIFERENCIAL LADO DA CAIXA DE VELOCIDADES	
	R4 R5 R6 R12
4530006	
	∅F _G -63 ∅F _P -20 A-120

FOLE DO SEMI-EIXO DIFERENCIAL LADO DA RODA	
	R4 R5 até 84 R5 exepto ALPINE R6
4530020	
7701457538	ØF _G -68 ØF _P -17 A-100

FOLE DO SEMI-EIXO DIFERENCIAL LADO DA RODA	
	R4 R5 R6
4530054	
7701013273	ØF _G -65 ØF _P -19.5 A-94

FOLE DA DIRECÇÃO	
	R5
4530055	
7702118974	ØF _G -32.5 ØF _P -10 A-170

FOLE DO SEMI-EIXO DIFERENCIAL LADO DA RODA	
	SUPER 5 R9 R11 R18 Moderno EXPRESS
4530056	
	ØF _G -86 ØF _P -28 A-114

FOLE DO SEMI-EIXO DIFERENCIAL LADO DA CAIXA DE VELOCIDADES	
	R5 desde 85 SUPER 5 exepto GT TURBO R9 R11 R21 TS - TSE - GTS EXPRESS
4530131	
7701462101	ØF _G -80 ØF _P -27 A-113

FOLE DO SEMI-EIXO DIFERENCIAL LADO DA RODA	
	R5 ALPINE TURBO R12 R14 R15 R16 R17 R20 TL - GTL
4530132	
7701200694	ØF _G -78 ØF _P -23 A-135

FOLE DIREITO DO SEMI-EIXO DIFERENCIAL LADO DA CAIXA DE VELOCIDADES	
	SUPER 5 GT TURBO R9 TURBO R18 TD R18 GTD desde 83 R25 TD R25 GTD
4530133	
7701463586	ØF _G -78 ØF _P -33 A-110

FOLE DO SEMI-EIXO DIFERENCIAL LADO DA RODA	
	R18 TX - GTX - TURBO R20 TD - TS - TX R25 V6 R30 SPACE FUEGO TRAFIC
4530134	
7701201452	ØF _G -84 ØF _P -21 A-124



FOLE DO SEMI-EIXO DIFERENCIAL LADO DA RODA	
	TRAFIC
4530135	
7701201810	ØF _G -94 ØF _P -25 A-128

FOLE DO SEMI-EIXO DIFERENCIAL LADO DA RODA	
	TRAFIC
4530136	
7701202237	ØF _G -82 ØF _P -23 A-122

FOLE DO SEMI-EIXO DIFERENCIAL LADO DA CAIXA DE VELOCIDADES - COM ROLAMENTO DE 25.8mm	
	R5 SUPER 5 R9 R11 R19 R21 TS - TSE - GTS CLIO 1.8 TWINGO EXPRESS
4530142	
7701462100 7701462308	ØF _G -85 ØF _P -25.8 A-80

FOLE DO SEMI-EIXO DIFERENCIAL LADO DA RODA	
	R4 R5 R6
4530143	
7701457538	ØF _G -68 ØF _P -17 A-100

FOLE DO SEMI-EIXO DIFERENCIAL LADO DA CAIXA DE VELOCIDADES - COM ROLAMENTO DE 22.8mm	
	SUPER5 GT TURBO R9 R11 EXPRESS
4530144	
7701463955 7701464582	ØF _G -85 ØF _P -22.8 A-80

FOLE ESQUERDO E DIREITO DA DIRECÇÃO	
	R4 até 6/79 R5 até 6/79 R6 até 6/79
4530145	
7700554294	ØF _G -33 ØF _P -26 A-100

FOLE CENTRAL DO AMORTECEDOR ANTERIOR	
	CLIO
4530147	
7700802667	ØF _G -54.5 ØF _P -18.5 A-195

FOLE ESQUERDO E DIREITO DA DIRECÇÃO	
	SUPER 5 R9 exepto GTE TURBO R11 exepto GTE TURBO R19 sem direcção assistida R21 sem direcção assistida CLIO sem direcção assistida TWINGO sem direcção assistida EXPRESS
4530151	
7700678649 7700781097	ØF _G -28 ØF _P -10 A-160

FOLE ESQUERDO DA DIRECÇÃO	
	R9 R11 GTE TURBO R18 D - TD - TURBO R20 - R25 - R30 FUEGO TRAFIC sem direcção assistida
4530152	
7700680852	∅F _G -32 ∅F _P -10 A-200

FOLE ESQUERDO E DIREITO DA DIRECÇÃO	
	R9 só lado direito R11 GTE TURBO só lado direito R18 TL - GTL R18 D - TURBO até 6/82 R18 TD só lado direito após 7/82 R20 R25
4530153	
7700653459	∅F _G -40 ∅F _P -10 A-155

FOLE ESQUERDO E DIREITO DA DIRECÇÃO	
	R30 sem direcção assistida FUEGO TRAFIC sem direcção assistida
4530153	
7700653459	∅F _G -40 ∅F _P -10 A-155

FOLE DO SEMI-EIXO DIFERENCIAL LADO DA RODA	
	SUPER 5 GT TURBO R9 - R11 R19 1.4 - 1.7 R21 TS - GTS - TSE R25 CLIO 1.2 - 1.4 - D EXPRESS 1.1 - 1.6D
4530154	
7701465489 7701466122	∅F _G -83 ∅F _P -34 A-134

FOLE DO SEMI-EIXO DIFERENCIAL LADO DA CAIXA DE VELOCIDADES - COM ROLAMENTO 23.8mm	
	SUPER 5 D R19 CLIO 1.2 - 1.4 CLIO D EXPRESS
4530155	
7701464129 7701464141	∅F _G -89 ∅F _P -23.8 A-75

FOLE DO SEMI-EIXO DIFERENCIAL LADO DA RODA	
	R5 ALPINE - TURBO R12 - R14 R15 - R16 - R17 R18 TS - GTS - D R20 TD - GTD
4530169	
7701455096 7701457539	∅F _G -78 ∅F _P -20 A-116

FOLE DIREITO DO SEMI-EIXO DIFERENCIAL LADO DA RODA	
	SUPER 5 exepto GT TURBO R9 R11 R19 TR - GTR - TRE EXPRESS 1.1 - 1.6D
4530171	
7701463643	∅F _G -75 ∅F _P -20 A-83

FOLE DO SEMI-EIXO DIFERENCIAL LADO DA RODA	
	SUPER 5 GT TURBO R9 R11 R19 D R21 1.7 CLIO 1.2 - 1.4 - D KANGOO D
4530174	
7701465489 7701466122	∅F _G -83 ∅F _P -34 A-140

FOLE DO SEMI-EIXO DIFERENCIAL LADO DA RODA	
	MEGANE SCENIC 1.4 16V - 1.6 MEGANE SCENIC 1.6 16V EXPRESS 1.4 - 1.9D
4530174	
7701465489 7701466122	∅F _G -83 ∅F _P -34 A-140

FOLE DA DIRECÇÃO	
	CLIO II
4530177	
7701471141	∅F _G -42 ∅F _P -11 A-150

FOLE DO SEMI-EIXO DIFERENCIAL LADO DA CAIXA DE VELOCIDADES	
	KANGOO 1.4
4530180	
	∅F _G -74 ∅F _P -23 A-97

FOLE DO SEMI-EIXO DIFERENCIAL LADO DA RODA	
	R21 TXE - TD CLIO 1.2 - 1.4 - D CLIO II KANGOO 1.2 - 1.4 - D - DTI LAGUNA SAFRANE TWINGO
4530182	
7701467125	∅F _G -79 ∅F _P -26 A-124

FOLE PLASTICO DO SEMI-EIXO DIFERENCIAL LADO DA RODA	
	R21 TXE - TD CLIO 1.2 - 1.4 - D CLIO II KANGOO 1.2 - 1.4 - D - DTI LAGUNA SAFRANE TWINGO
4530183	
7701467125	∅F _G -82 ∅F _P -24 A-137

FOLE DA CREMALHEIRA DA DIRECÇÃO	
	CLIO II
4530184	
7701469486	∅F _G -40 ∅F _P -12 A-175

FOLE DA CREMALHEIRA DA DIRECÇÃO	
	CLIO II KANGOO
4530185	
7701469496	∅F _G -39 ∅F _P -9 A-161

FOLE DA CREMALHEIRA DA DIRECÇÃO	
	CLIO II 1.2 sem direcção assis. KANGOO
4530187	
7701470753	∅F _G -39 ∅F _P -9 A-169



FOLE DO SEMI-EIXO DIFERENCIAL LADO DA RODA	
	R18 BREAK TX - GTX R19 1.4 - 1.7 R21 TX - GTX R21 TD - GTD R25 R30 TX - TS
4560045	
7701033432 7701202583	ØF _G -83 ØF _P -22 A-84

FOLE DO SEMI-EIXO DIFERENCIAL LADO DA RODA	
	CLIO ESPACE TRAFIC
4560045	
7701033432 7701202583	ØF _G -83 ØF _P -22 A-84

FOLE DO SEMI-EIXO DIFERENCIAL LADO DA CAIXA DE VELOCIDADES	
	R19 R21 CLIO
4560062	
7701034903	ØF _G -94 ØF _P -20 A-78.5

PALAS DE CAMIÃO	
	RENAULT
4450095	
	C-600 L-340

JOGO DE PALAS RENAULT	
	SUPER 5 R21 EXPRESS
4530188	
	C-335 L-210

JOGO DE PALAS RENAULT	
	R19
4530189	
	A-255 L-208

JOGO DE PALAS RENAULT	
	CLIO
4530190	
	A-257 L-258

SILENT-BLOC DO BRAÇO SUPERIOR DA SUSPENSÃO ANTERIOR	
	R5
4530012	
7700542251	ØE-26 ØF-12 A _E -23 A-36



SILENT-BLOC DO BRAÇO INFERIOR DA SUSPENSÃO ANTERIOR	
	R12 R18
4530013	
7700514109 7701348038	ØE-32 ØF-14 A _E -38 A _I -46

SILENT-BLOC DA EXTREMIDADE DA CREMALHEIRA DA DIRECÇÃO	
	R4 R5 R6 R12 R16 R18
4530014	
7700509247 7702042315 8546375	ØE-28 ØF-10 A _E -20 A _I -27

SILENT-BLOC DO BRAÇO SUPERIOR DA SUSPENSÃO ANTERIOR	
	R4 R6
4530015	
7700104152 7700518392 7700518856	ØE-26 ØF-12 A _E -23 A _I -27

SILENT-BLOC DO BRAÇO SUPERIOR DA SUSPENSÃO ANTERIOR	
	R12 R18 Gas.
4530016	
7700514110 7701348038 7702107331 7705040000	ØE-27 ØF-14 A _E -43.5 A _I -51

SILENT-BLOC DO BRAÇO INFERIOR DA SUSPENSÃO POSTERIOR	
	R5
4530017	
7700533100 7700574081 7701349773	ØE-34 ØF-14 A _E -40 A _I -45

SILENT-BLOC DO SUPORTE ANTERIOR DO MOTOR	
	R12
4530018	
7700535085 7700525816 7700553705	ØE-34 ØF-10 A _E -25 A _I -28

SILENT-BLOC DO SUPORTE ANTERIOR DO MOTOR	
	R12
4530019	
7700525815	ØE-52 ØF-10 A _E -28 A _I -32

SILENT-BLOC DO BRAÇO INFERIOR DA SUSPENSÃO ANTERIOR	
	SUPER 5 R9 R11 R21 TL - TS - GTS - TSE - RS EXPRESS
4530036	
7700762574 7704000681	ØE-32 ØF-12 A _E -36 A _I -46



SILENT-BLOC DO BRAÇO INFERIOR DA SUSPENSÃO ANTERIOR	
	R4 R5 R6
4530037	
8545885 8558426 7701348454	ØE-27 ØF-14 A _E -40 A _I -45

SILENT-BLOC DO BRAÇO INFERIOR DA SUSPENSÃO ANTERIOR	
	R18 D
4530057	
7704001281	ØE-36 ØF-14 A _E -38 A _I -53

SILENT-BLOC ANTERIOR DO BRAÇO INFERIOR DA SUSPENSÃO ANTERIOR	
	R21 TD R21 GTD R21 TXE
4530062	
7700754515 7700785937	ØE-36 ØF-12 A _E -39 A _I -51

SILENT-BLOC POSTERIOR DO BRAÇO INFERIOR DA SUSPENSÃO ANTERIOR	
	R21 D R21 TD
4530063	
7700772687	ØE-36 ØF-12 A _E -37 A _I -48.5

SILENT-BLOC INTERNO DO BRAÇO DE SUSPENSÃO POSTERIOR	
	R5 R14
4530065	
7700531821 7700586284	ØE-55 ØF-37 A _E -27.5 A _I -33

SILENT-BLOC DO BRAÇO DE SUSPENSÃO POSTERIOR	
	R5 R14
4530066	
7700531796 7700638674 7700850319	ØE-55 ØF-37 A _E -27.5 A _I -59

SILENT-BLOC ANTERIOR DO BRAÇO SUSPENSÃO POSTERIOR	
	SUPER 5
4530070	
7704003844	ØE-72 ØF-43 A _E -28 A _I -28

SILENT-BLOC DA SUSPENSÃO	
	
4530071	
	ØE-40 ØF-14 A _E -36 A _I -48



SILENT-BLOC ANTERIOR DO BRAÇO SUSPENSÃO ANTERIOR	
	R19 CLIO
4530072	
7700799065	ØE-40 ØF-12 A _E -35.5 A _I -46

SILENT-BLOC DO ALTERNADOR	
	R5 R9 R11 R18 TRAFIC
4530091	
7700612542	ØE-25.5 ØE _A -30 A-25

SILENT-BLOC DA SUSPENSÃO POSTERIOR	
	R9 R11
4530099	
	ØE-72 ØF-43 A _E -36 A _I -36

SILENT-BLOC DO BRAÇO DE SUSPENSÃO ANTERIOR	
	R19
4530104	
7700789478	ØE-45 ØE _A -47.5 ØF-12 A-45.5

SILENT-BLOC DIREITO DO BRAÇO DE SUSPENSÃO ANTERIOR	
	TWINGO
4530105	
7700831364	ØE-38 ØE _A -48.5 ØF-12 A-46

SILENT-BLOC ESQUERDO DO BRAÇO DE SUSPENSÃO ANTERIOR	
	TWINGO
4530106	
7700819929	ØE-36 ØF-12 A _E -34 A _I -45.5

SILENT-BLOC DA SUSPENSÃO POSTERIOR	
	TRAFIC
4530119	
7700730733	ØE-46.5 ØE _A -54.5 ØF-22 A-81

SILENT-BLOC DO BRAÇO DE SUSPENSÃO POSTERIOR	
	CLIO
4530121	
	ØE-77 ØF-43 A _E -28 A _I -28

SILENT-BLOC DO BRAÇO DE SUSPENSÃO POSTERIOR	
	R19
4530126	
	ØE-77 ØF-43 A _E -35.5 A _I -35.5

JOGO DE DOIS SILENT-BOLCS PARA AMORTECEDOR POSTERIOR	
	MASTER
4530170	
	ØE-28 ØF-12 A _E -23 A _I -31.5 ØE-32.5 ØF-14 A _E -20 A _I -51.5

SILENT-BLOC DO BRAÇO DE SUSPENSÃO ANTERIOR	
	CLIO II KANGOO
4530178	
7700424399	ØE-45.5 ØE _A -59 ØF-12 A-46

SILENT-BLOC DO BRAÇO INFERIOR DA SUSPENSÃO ANTERIOR	
	14
4580028	
7910012946	ØE-38 ØF-14 A _E -24 A _I -42

TUBO SUPERIOR DE ENTRADA DE ÁGUA DO RADIADOR - COM VÁLVULA	
	CLIO 1.1
4530138	
7700801058 6006003616	ØF _G -38 ØF _P -30

TUBO INFERIOR DE SAÍDA DE ÁGUA DO RADIADOR	
	TRAFIC D
4530139	
7700672945	ØF-30

TUBO INFERIOR DE SAÍDA DE ÁGUA DO RADIADOR	
	R5 TL R5 GTL R5 TS R5 ALPINE
4530141	
7700533016	ØF-30

TUBO SUPERIOR DE ENTRADA DE ÁGUA DO RADIADOR	
	CLIO 1.2 CLIO 1.4
4530149	
7700801054	ØF _G -34 ØF _P -30

TUBO INFERIOR DE SAÍDA DE ÁGUA DO RADIADOR	
	R9 R11 1.1 Gas. R11 1.4 Gas.
4530150	
7704001277	ØF _G -40 ØF _P -30

TUBO INFERIOR DE SAÍDA DE ÁGUA DO RADIADOR	
	SUPER 5 TL - GTL - GTS SUPER 5 SL - TC EXPRESS Gas.
4530156	
7700752184 7700781076	ØF _G -38 ØF _P -30

TUBO INFERIOR DE TRÊS VIAS DE SAÍDA DE ÁGUA DO RADIADOR	
	R19 GTX - TSE - TXE - GTE R19 TD - GTD - TDE
4530157	
7700795305 7700796216	ØF _G -2x29 ØF _P -19

TUBO SUPERIOR DE ENTRADA DE ÁGUA DO RADIADOR - COM VÁLVULA	
	SUPER 5 TL - GTL - GTS SUPER 5 SL - TC EXPRESS Gas.
4530158	
7700762342	ØF _G -38 ØF _P -32

TUBO SUPERIOR DE ENTRADA DE ÁGUA DO RADIADOR - COM VÁLVULA	
	R9 R11 1.1 R11 1.4
4530159	
7700760872 7704001275	ØF _G -41 ØF _P -31

TUBO SUPERIOR DE ENTRADA DE ÁGUA DO RADIADOR	
	R19 TD - GTD - TDE
4530160	
7700790238	ØF _G -34 ØF _P -31

TUBO INFERIOR DE SAÍDA DE ÁGUA DO RADIADOR	
	R19 TR - GTR - TRE
4530161	
7700790240	ØF _G -39 ØF _P -29

TUBO INFERIOR DE TRÊS VIAS DE SAÍDA DE ÁGUA DO RADIADOR	
	CLIO 1.2 - 1.4
4530162	
7700801055	ØF-30 ØF-28 ØF-22.5



TUBO SUPERIOR DE ENTRADA DE ÁGUA DO RADIADOR - COM VÁLVULA	
	R19 TS R19 GTS
4530163	
7700790231 7700793619	ØF _G -32 ØF _P -30

TUBO SUPERIOR DE ENTRADA DE ÁGUA DO RADIADOR	
	R19 GTX - TSE - TXE - GTE
4530164	
7700787606	ØF-31 ØF-29

TUBO INFERIOR DE SAÍDA DE ÁGUA DO RADIADOR COM PROTECÇÃO EM BORRACHA	
	R19 TS - GTS
4530165	
7700790234 7700793617	ØF-30 ØF-27

TUBO DE TRÊS VIAS DO AQUECIMENTO	
	CLIO 1.2 - 1.4
4530167	
7700801056	ØF-19.5 ØF-16.5 ØF-10

TUBO INFERIOR DE QUATRO VIAS DE SAÍDA DE ÁGUA DO RADIADOR	
	CLIO D EXPRESS 1.9 D
4530168	
7700801067	ØF-30 ØF-27 ØF-17.5 ØF-15



CASQUILHO	
	GALERA ROR
4450004	
210-20676	ØE-88.5 ØF-41 A-112

CASQUILHO	
	ROR
4450019	
21215752	ØE-42 ØF-20 A-62

FOLE	
	ROR
4450016	
21204849	ØE-60 ØF-35 A-26

ANILHA	
	ROR
4450017	
21205667	ØE-53 ØF-35.5 A-10.5

CASQUILHO DE MOLAS	
	ROR
4450049	



SILENT-BLOC DA SUSPENSÃO	
	214 216
4526001	
	ØE-80 ØF-12.5 A-39.7



BATENTE DA BARRA ESTABILIZADORA	
	SCANIA VOLVO
4450062	
767.334	ØF-46 A-76 C-79 L-60

BATENTE DE ESTABILIZADOR CENTRO	
	SCANIA 81 - 82 - 92 - 93 - 111 SCANIA 113 - 140 - 141 - 142 SCANIA 143
4450112	
213604	ØF-40 A-64 C-124 L-74

CASQUILHO DE AMORTECEDORES	
	SCANIA
4450073	
241922	ØE-47 ØF-21.5 A-26.5

CASQUILHO DA PONTA DA BARRA ESTABILIZADORA	
	SCANIA
4450123	
310808	ØE-57 ØF-20 A-31.5

PALAS DE CAMIÃO	
	SCANIA
4450091	
	C-600 L-340

SILENT-BLOC DE MOLAS	
	SCANIA PNEUMÁTICO 113 140 - 141 - 142 - 143 - 145 146
4450067	
255669	ØE-65 ØF-30 A _E -117 A _r -122

SILENT-BLOC DE MOLAS DE SISTEMA PNEUMÁTICO	
	SCANIA MODERNA 113 - 124 143
4450068	
	ØE-65 ØF-30 A _E -97 A _r -101.5

SILENT-BLOC DA CABINA	
	SCANIA 82 - 92 - 93 - 112 SCANIA 113 - 143
4450069	
320775	ØE-50 ØF-16 A _E -66 A _r -80



SILENT-BLOC DE MOLAS	
	SCANIA 113 · 124 · 143
4450084	
	∅E-65 ∅F-30 A _E -102 A _F -121.5

SILENT-BLOC SCANIA	
	
4450122	
	∅E-42 ∅F-23 A _i -60

SUPORTE ANTERIOR DO MOTOR	
	IBIZA 1.2 Sistema FIAT IBIZA 1.5 Sistema FIAT MALAGA RONDA
4525003	
SE831154205A	ØF-12.5 A-58 C-135 L-85

SUPORTE DE MOTOR	
	IBIZA Sistema FIAT MALAGA RONDA
4525006	
SE138117405B X05920938	ØF-12 ØF-2x16 A-65 C-133.5 L-80

SUPORTE ANTERIOR DO MOTOR	
	IBIZA D Sistema FIAT MALAGA D RONDA
4525007	
SE700154205A	ØF-16\12 ØF-2x16 A-47.5 C-133.5 L-80.5

SUPORTE DE MOTOR LADO DA CAIXA DE VELOCIDADES	
	IBIZA Sistema FIAT MALAGA D RONDA D
4525008	
SE138154605A	ØF-12 ØF-2x16 A-49 C-133 L-80

SUPORTE SUPERIOR DO AMORTECEDOR ANTERIOR - SEM ROLAMENTO	
	IBIZA
4525016	
SE021156228A	ØE-76 ØF-21 A-42.5

SUPORTE ANTERIOR DO MOTOR	
	TOLEDO D
4560002	
191199279C	ØFr-8 ØFr-10 ØP-10 A-23

SUPORTE ANTERIOR DO MOTOR	
	TOLEDO
4560005	
191199262A	ØF-11.5 A-123.5 C-109 L-75.5

SUPORTE POSTERIOR ESQUERDO DO MOTOR	
	TOLEDO
4560006	
191199402 191199402A 191199402B 191199402B	ØFr-10 ØF-2x10 A-82.5 C-137 L-82



SUPORTE SUPERIOR DO AMORTECEDOR ANTERIOR	
	IBIZA CORDOBA TOLEDO
4560022	
191412329	ØE-129 ØF-14 A-52

SUPORTE ANTERIOR DO MOTOR HIDRÁULICO	
	TOLEDO D
4560025	
191199279C	ØFr-8 ØFr-10 ØP-10 A-P-23

SUPORTE POSTERIOR DIREITO DO MOTOR COM CARÇAÇA	
	CORDOBA 1.9D IBIZA 1.9D
4560026	
1H0199262B	A-130 C-154 L-107

SUPORTE ANTERIOR DO MOTOR SEM CARÇAÇA	
	IBIZA 1.9D desde 2/93 CORDOBA 1.9D desde 2/93
4560027	
1H0199609B	ØFr-2x10 A-133 C-107

SUPORTE POSTERIOR DIREITO DO MOTOR	
	TOLEDO 1.8
4560039	
535199262 191199262C	ØFr-2x10 ØFr-3x8 A-130 L-101

SUPORTE POSTERIOR DO MOTOR LADO DA CAIXA DE VELOCIDADES	
	IBIZA 1.0 - 1.4 TOLEDO
4560078	
191199381A	ØF-2x10 ØFr-10 A-66.5 C-137 L-82.5

FOLE CENTRAL DO AMORTECEDOR ANTERIOR	
	IBIZA CORDOBA
4525023	
357412303F	ØF-18 ØE-50 A-83

BATENTE SUPERIOR DO AMORTECEDOR ANTERIOR	
	IBIZA CORDOBA TOLEDO
4560028	
191412303A 1H0412303A 357412303E	ØE-59.5 A-84



BATENTE CENTRAL DO AMORTECEDOR POSTERIOR - COM RESGUARDO	
	IBIZA TOLEDO após 5/91
4560029	
191512131 191512131B	ØE-56 ØF-14 ØF-11 A-150

BATENTE DA BARRA ESTABILIZADORA ANTERIOR	
	TOLEDO
4560036	
191411314	ØF-16 A-36 C-34 L-32.5

CASQUILHO DA EXTREMIDADE DA CREMALHEIRA DA DIRECÇÃO	
	FURA IBIZA Sistema FIAT MARBELLA RONDA
4525013	
SE138162130A	ØF-20.5 A-18.5 C-28 L-28

CASQUILHO DO BRAÇO DE SUSPENSÃO ANTERIOR	
	IBIZA Sistema FIAT exepcto 0.9 MALAGA Gas. MARBELLA RONDA Gas. TERRA
4525014	
SE132156127A	ØE-55 ØF-23 A-32

CASQUILHO DO BRAÇO DE SUSPENSÃO ANTERIOR	
	IBIZA Sistema FIAT exepcto 0.9 MALAGA Gas. MARBELLA RONDA Gas. TERRA
4525018	
SE132156126A	ØE-55 ØF-23 A-26

APOIO DA EXTREMIDADE DA TRAVESSA ANTERIOR	
	CORDOBA 1.0 - 1.9 IBIZA 1.0 - 1.9 TOLEDO 1.6 - 2.0
4560047	
191199233	ØE-51 ØF-16 A-40

CAPA DE PEDAL DO ACELERADOR	
	IBIZA Sistema FIAT FURA MALAGA Gas. RONDA
4520013	
4187379 SE021110044A	C-96.5 L-43.5

CAPA DE PEDAL DO TRAVÃO E EMBRAIAGEM	
	FURA IBIZA Sistema FIAT MARBELLA até 86 TERRA
4520014	
4144275 SE127126025A 2101-1602048	C-64.5 L-50



CAPA DE PEDAL DO TRAVÃO E EMBRAIAGEM	
	IBIZA Sistema FIAT MARBELLA FURA RONDA TERRA
4520056	
4144275 SE127126025A	C-64 L-50.5

CAPA DE PEDAL DO TRAVÃO E EMBRAIAGEM	
	IBIZA Sistema FIAT desde 3/86 MALAGA MARBELLA desde 3/86 RONDA desde 3/86
4525010	
SE138126025A	A-10 C-79.5 L-48

CAPA DE PEDAL DO TRAVÃO E EMBRAIAGEM	
	IBIZA CORDOBA TOLEDO
4560014	
321721173	A-10 C-66 L-55

TAMPA DA VARETA DO ÓLEO	
	FURA MARBELLA
4520045	
SE020030136A 4102056 4328493	ØE-17 A-42

CRUZETA PLÁSTICA	
	IBIZA MALAGA
4525009	
SE021129110C	ØF _G -11.5 ØF _P -10 C-30 L-30

BOTÃO DE CAPOT	
	IBIZA Sistema FIAT MALAGA MARBELLA
4525011	
SE128559910A	ØE-17 A-43

TIRANTE DE FIXAÇÃO DA CHAPELAEIRA	
	IBIZA Sistema FIAT
4525012	
X043620010	C-331

ESTICADOR DA BARRA ESTABILIZADORA	
	IBIZA TOLEDO
4560012	
191411315	ØF-15.5 ØP-10 A _P -45 A-40 C-94

BATENTE DO TUBO DE ESCAPE	
	TOLEDO
4560023	
431253149A	∅E-20 ∅F-5 A-35

ESTICADOR DE ESCAPE	
	FURA
4520051	
2101-1203072 4296059 SE127115138A 4312280	∅F-6.5 A-33.5 C-79.5 L-36

ANEL DO TUBO DE ESCAPE	
	IBIZA RITMO MALAGA RONDA
4525002	
Rf11551400	∅E-55.5 A-9.5

SUPORTE DO TUBO DE ESCAPE	
	
4525004	
Ge11513901	A-13 C-74.5 L-64

SUPORTE POSTERIOR DO TUBO DE ESCAPE	
	IBIZA Sistema FIAT MALAGA MARBELLA RONDA TERRA
4525005	
SE138115503A	A-27.5 C-54 L-44

SUPORTE POSTERIOR DO TUBO DE ESCAPE	
	IBIZA Sistema FIAT MALAGA TERRA
4530028	
SE021115504A	∅F-4x8.5 A-31 C-87.5 L-26.5

SUPORTE DO TUBO DE ESCAPE	
	CORDOBA IBIZA
4560076	
1H0253147B	∅F-2x12 A-34 C-70 L-50

SUPORTE DO TUBO DE ESCAPE	
	TOLEDO
4575008	
803253147	A-13 C-63 L-52



FOLE DO SEMI-EIXO DIFERENCIAL LADO DA RODA	
	IBIZA Sistema FIAT MALAGA MARBELLA após 11/77 FURA após 11/77 RONDA após 11/77 TERRA de 1/84 a 88
4520038	
SE127141537A	ØF _G -68 ØF _P -20 A-80

FOLE DIREITO DA DIRECÇÃO	
	IBIZA Sistema FIAT MALAGA MARBELLA FURA RONDA TERRA
4520040	
SE138162132A 4239459 4371156	ØF _G -26 ØF _P -10 A-165

FOLE DO SEMI-EIXO DIFERENCIAL LADO DA CAIXA DE VELOCIDADES	
	MARBELLA de 10/82 a 1/85 FURA de 10/82 a 1/85 RONDA de 10/82 a 1/85 TERRA de 10/82 a 88
4520046	
92601216 92601171	ØF _G -64 ØF _P -23 A-73

FOLE SUPERIOR DO AMORTECEDOR ANTERIOR	
	MARBELLA FURA
4520061	
4409263 X04409263	ØF _G -60 ØF _P -20 A-182

FOLE ESQUERDO DA DIRECÇÃO	
	IBIZA Sistema FIAT MALAGA MARBELLA FURA RONDA TERRA
4520063	
SE138162131A 4239458 4371155	ØF _G -42 ØF _P -10 A-125

FOLE DO SEMI-EIXO DIFERENCIAL LADO DA RODA	
	TERRA após 88
4520071	
	ØF _G -65 ØF _P -19.5 A-81

FOLE DO SEMI-EIXO DIFERENCIAL LADO DA CAIXA DE VELOCIDADES	
	TERRA de 10/82 a 88
4520072	
92601366	ØF _G -79 ØF _P -23 A-75

FOLE DIREITO DO SEMI-EIXO DIFERENCIAL LADO DA CAIXA DE VELOCIDADES	
	IBIZA Sistema FIAT MALAGA TERRA após 88
4520085	
SE022141931A	ØF _G -74 ØF _P -30 A-85



KIT FOLE ESQUERDO DO SEMI-EIXO LADO DA CAIXA DE VELOCIDADES - EIXO 23mm	
	IBIZA Sistema FIAT MALAGA TERRA
4520087	
	∅F _G -30 ∅F _P -80 A-82

KIT FOLE DIREITO DO SEMI-EIXO LADO DA CAIXA DE VELOCIDADES - EIXO 23mm	
	IBIZA Sistema FIAT MALAGA Fole esquerdo TERRA após 88
4520088	
	∅F _G -74 ∅F _P -30.5 A-86

FOLE DO SEMI-EIXO DIFERENCIAL LADO DA CAIXA DE VELOCIDADES	
	FURA IBIZA Sistema FIAT MALAGA MARBELLA RONDA
4520127	
4333088	∅F _G -64 ∅F _P -25 A-85

FOLE DO SEMI-EIXO DIFERENCIAL LADO DA RODA	
	127 PANDA
4525001	
HB14153700	∅F _G -74 ∅F _P -21 A-95

FOLE DA TRANSMISSÃO	
	IBIZA MALAGA RONDA
4525015	
	∅F _G -64 ∅F _P -30.5 A-93

FOLE DIREITO DO SEMI-EIXO DIFERENCIAL LADO DA CAIXA DE VELOCIDADES	
	TOLEDO 1.8 TOLEDO TD
4560035	
191407283 191498202	∅F _G -100 ∅F _P -36 A-120

FOLE DO SEMI-EIXO DIFERENCIAL LADO DA RODA	
	TOLEDO 1.8 TOLEDO D
4560045	
811498203 431407285B	∅F _G -83 ∅F _P -22 A-84

FOLE ESQUERDO E DIREITO DA DIRECÇÃO ASSISTIDA	
	CORDOBA IBIZA TOLEDO
4560048	
175422831 191422831 1H0422831	∅F _G -42 ∅F _P -10 A-210



FOLE ESQUERDO E DIREITO DA DIRECÇÃO VIATURAS SEM DIRECÇÃO ASSISTIDA	
	CORDOBA IBIZA TOLEDO
4560061	
191419831	ØF _G -40.5 ØF _P -25 A-120

FOLE DO SEMI-EIXO DIFERENCIAL LADO DA CAIXA DE VELOCIDADES	
	TOLEDO 1.6 TOLEDO D TERRA
4560062	
SE171498201A	ØF _G -94 ØF _P -20 A-78.5

FOLE EM NYLON DO AMORTECEDOR ANTERIOR	
	TOLEDO
4560063	
191412135 357412135	ØF _G -70 ØF _P -53 A-94

FOLE DO SEMI-EIXO DIFERENCIAL LADO DA RODA	
	CORDOBA IBIZA TOLEDO 1.6 TOLEDO D
4560067	
	ØF _G -77 ØF _P -25 A-107

FOLE DO AMORTECEDOR ANTERIOR	
	CORDOBA IBIZA
4560082	
357413175	ØF _G -59 ØF _P -57 A-165

SILENT-BLOC DO BRAÇO DE SUSPENSÃO POSTERIOR	
	IBIZA Sistema FIAT MALAGA RONDA
4525019	
SE138156532A	ØE-30 ØE _A -40.5 ØF-13 A-43

SILENT-BLOC DA SUSPENSÃO	
	IBIZA
4525020	
	ØE-60 ØF-17 A _E -24 A _r -41

SILENT-BLOC DO BRAÇO DE SUSPENSÃO ANTERIOR	
	CORDOBA IBIZA
4560003	
191407181D 191407181E	ØE-60 ØF-17 A _E -24 A _r -41

SILENT-BLOC DO BRAÇO DE SUSPENSÃO ANTERIOR	
	IBIZA CORDOBA TOLEDO
4560017	
191407182 357407182	ØE-32.5 ØE _A -36 ØF-12 A-54

SILENT-BOLC DO BRAÇO DE SUSPENSÃO ANTERIOR	
	TOLEDO
4560031	
191407181A 191407181B	ØE-60 ØE _A -67.5 ØF-17 A-41.5

SILENT-BLOC DO BRAÇO DE SUSPENSÃO ANTERIOR	
	CORDOBA IBIZA TOLEDO
4560040	
191407182 357407182	ØE-33 ØE _A -35.5 ØF-12 A-54

SUPORTE DA SUSPENSÃO POSTERIOR	
	TOLEDO
4560044	
191501541	ØE-44.5 ØF-12 A-90

TUBO SUPERIOR DE ENTRADA DE ÁGUA DO RADIADOR	
	FURA
4520120	
SE127117224A	ØF-31 ØF-31

TUBO INFERIOR DE SAÍDA DE ÁGUA DO RADIADOR	
	FURA
4520129	
SE127117207A	ØF-34 ØF-34

TUBO INFERIOR DE SAÍDA DE ÁGUA DO RADIADOR	
	IBIZA 1.0 - 1.6 CORDOBA 1.0 - 1.6
4525021	
6K0121051	ØF _G -30 ØF _P -29

TUBO DE LIGAÇÃO DA BOMBA AO TERMOSTATO	
	IBIZA 1.0 IBIZA 1.3 IBIZA 1.4
4525022	
030121063C	ØF _G -30 ØF _P -28.5



TUBO INFERIOR DE SAÍDA DE ÁGUA DO RADIADOR	
	IBIZA 1.1 - 1.5 Sistema FIAT MALAGA 1.2 - 1.5
4525024	
SE021117207A	ØF-34 ØF-34

TUBO DE LIGAÇÃO DA BOMBA DE ÁGUA AO TERMOSTATO	
	TOLEDO 1.6 após 5/91 TOLEDO 1.8 após 5/91
4560049	
026121053A 026121053F 026121053G	ØF-24 ØF-24

TUBO INFERIOR DE SAÍDA DE ÁGUA DO RADIADOR	
	TOLEDO 1.8 após 5/91 TOLEDO 2.0 após 5/91 TOLEDO 1.9D após 5/91
4560059	
191121051G 191121051P	ØF _G -32 ØF _P -30

TUBO SUPERIOR DE ENTRADA DE ÁGUA DO RADIADOR	
	TOLEDO 1.6 TOLEDO 1.8
4560064	
191101101D 191121101F 191121101S	ØF-30 ØF-30

TUBO INFERIOR DE SAÍDA DE ÁGUA DO RADIADOR	
	TOLEDO 1.6 - 1.8 após 5/91
4560072	
191121051F	ØF-31 ØF-31

TUBO DE LIGAÇÃO DA BOMBA DE ÁGUA AO TERMOSTATO	
	TOLEDO 1.6 TOLEDO 1.8
4575005	
026121053A 026121053G 026121053F	ØF-33



FOLE DO SEMI-EIXO LADO DA CAIXA DE VELOCIDADES	
	LEONE
4516019	
6232-07190 23222-GA220	ØF _G -74 ØF _P -20 A-81

FOLE DO SEMI-EIXO LADO DA RODA	
	LEONE JUSTY
4516020	
23222-GA140 7232-22090	ØF _G -73 ØF _P -24 A-82



FOLE DO SEMI-EIXO LADO DA CAIXA DE VELOCIDADES	
	CULTUS SWIFT
4516019	
04438-20010 04438-32040 04438-32050	ØF _G -74 ØF _P -20 A-81

FOLE DO SEMI-EIXO LADO DA RODA	
	CULTUS SWIFT
4516020	
44118-64B10 44118-53B10	ØF _G -73 ØF _P -24 A-82



CARDAN DA DIRECÇÃO	
	SAMBA
4580016	
4040.18 4040.22	ØE-75 ØF-4x8 A-11.5

ANEL DE ESCAPE	
	
4535001	
	ØE-63 A-13.5

FOLE DO SEMI-EIXO DIFERENCIAL LADO DA RODA	
	SAMBA
4530020	
3293.40 3293.47	ØF _G -68 ØF _P -17 A-100

FOLE DO SEMI-EIXO DIFERENCIAL LADO DA RODA	
	1100
4530132	
17665200	ØF _G -78 ØF _P -23 A-135

FOLE DO SEMI-EIXO DIFERENCIAL LADO DA RODA	
	1000 SAMBA
4530169	
13617800 9403293419	ØF _G -78 ØF _P -20 A-116

FOLE DA TRANSMISSÃO	
	150 1000 1200 SOLARA HORIZON
4535002	
	ØF _G -76 ØF _P -28 A-115

FOLE DIREITO E ESQUERDO DA DIRECÇÃO	
	SAMBA
4580067	
4066.15 7910030073	ØF _G -40 ØF _P -10 A-175

SILENT-BLOC DO TRAPÉZIO SUPERIOR ANTERIOR	
	TODOS MODELOS
4535003	
167557	ØE-30.5 ØE _A -40 ØF-14 A-30



SILENT-BLOC DO TRAPÉZIO INFERIOR ANTERIOR	
	TODOS MODELOS
4535004	
12808806	ØE-32 ØE _A -43 ØF-16 A-48

SILENT-BLOC DO BRAÇO DE SUSPENSÃO ANTERIOR	
	SAMBA
4580028	
3523.14	ØE-38 ØF-14 A _E -24 A _I -42



APOIO DO VEIO DE TRANSMISSÃO	
	CROWN
4576016	
37230-30030	ØF-30 ØFR-2x10

APOIO POSTERIOR DO MOTOR	
	DYNA BU10
4576019	
12371-56010	

APOIO ANTERIOR DO MOTOR	
	DYNA RU20
4576021	
12361-58010	

APOIO POSTERIOR DO MOTOR	
	DYNA RU30
4576022	
12371-56010	

APOIO DO VEIO DE TRANSMISSÃO	
	DYNA BU20
4576024	
37230-36021	ØF-30

APOIO DO VEIO DE TRANSMISSÃO	
	DYNA RU30
4576025	
37230-36080	ØF-30

APOIO DO VEIO DE TRANSMISSÃO	
	DYNA BU89 - BU96
4576026	
37230-36070 37230-36061 37230-36062	ØF-30

APOIO ANTERIOR DO MOTOR	
	COROLLA
4576030	
12302-36070	



APOIO ANTERIOR DO MOTOR	
	COROLLA
4576031	
12301-22011 RH	

APOIO ANTERIOR DO MOTOR	
	COROLLA
4576032	
12302-24010 LH	

APOIO ANTERIOR DO MOTOR	
	COROLLA
4576033	
12301-24020 RH	

APOIO ANTERIOR DO MOTOR	
	COROLLA
4576034	
12302-13042 LH	

APOIO ANTERIOR DO MOTOR	
	COROLLA
4576035	
12301-13020 RH	

APOIO POSTERIOR DO MOTOR	
	COROLLA
4576036	
12371-24012	ØFr-2x10 A-35 C-116 L-83

APOIO POSTERIOR DO MOTOR	
	COROLLA
4576037	
12371-24012	ØFr-2x10 A-35 C-116 L-83

APOIO POSTERIOR DO MOTOR	
	COROLLA
4576038	
12371-13030	



APOIO POSTERIOR DO MOTOR	
	LAND CRUISER
4576042	
12372-47031	ØF-14 ØP-14 A _P -28,5 ØE-70 A-74,5

APOIO ANTERIOR DO MOTOR	
	HILUX RN10
4576044	
12361-49036	ØP-12 A _P -28 A-33,5 C-124 L-89

APOIO ANTERIOR DO MOTOR	
	HILUX RN25
4576045	
12361-39018	ØP-12 A _P -28 A-41 C-125 L-97

APOIO ANTERIOR DO MOTOR	
	HILUX LN55 - LN65 - LN85
4576046	
12361-54120 12361-54121	ØP-12 A _P -29 A-50 C-120 L-117

APOIO ANTERIOR DO MOTOR	
	HILUX LN40
4576047	
12361-35050	ØP-12 A _P -28 A-50 C-120 L-117

APOIO POSTERIOR DO MOTOR	
	HILUX RN20
4576048	
12371-33010	

APOIO POSTERIOR DO MOTOR	
	HILUX LN30
4576049	
12371-31040	

APOIO DO VEIO DE TRANSMISSÃO	
	HILUX RN20
4576050	
37207-35011	ØE-105 A-50

APOIO DO VEIO DE TRANSMISSÃO	
	HILUX LN40
4576051	
37230-35030	∅F-30 ∅FR-2x8

APOIO DO VEIO DE TRANSMISSÃO	
	HILUX LN55 - LN56 - LN85
4576052	
37230-35050	∅F-30 ∅FR-2x10

APOIO DO VEIO DE TRANSMISSÃO	
	HILUX LN65 4WD
4576053	
37230-35061	∅F-30

APOIO ANTERIOR DO MOTOR	
	CORONA RT40
4576065	
12361-31010	

APOIO ANTERIOR DO MOTOR	
	CORONA RT60
4576066	
12361-39025	

APOIO ANTERIOR DO MOTOR	
	CORONA RT100
4576067	
12361-39015	

APOIO POSTERIOR DO MOTOR	
	CORONA RT100
4576068	

APOIO ANTERIOR DO MOTOR	
	12T-U 13T-U
4576069	
12371-34030	

APOIO ANTERIOR DO MOTOR	
	CELICA
4576070	
12361-25010	

APOIO MOLAS FRENTE	
	COROLA EB90
4576119	
	∅F-12.5 ∅FR-2x10 A-117 C-97 L-55

SUPORTE DO TUBO DE ESCAPE	
	DYNA BJ40 - BU81 - BU89 LAND CRUISER após 81
4576100	
17567-61010 17567-61030	∅P-4x6 A _P -4x13.5 A-31 C-55 L-35

BATENTE DA BARRA ESTABILIZADORA	
	COROLLA
4576006	
48815-12050	∅F-15.5 A-46 C-40 L-40

BATENTE DA BARRA ESTABILIZADORA	
	LAND CRUISER
4676043	
48815-60010	∅F-20 A-42 C-40 L-40

BATENTE DA BARRA ESTABILIZADORA	
	HILUX RN20
4576058	
48815-20020	∅F-14 A-37 C-40 L-40.5

BATENTE DA BARRA ESTABILIZADORA	
	HIACE LH50 - LH51
4576063	
48815-26020	∅F-16 A-36 C-39.5 L-40

BATENTE DE MOLAS	
	DYNA BU 70 - BU 80 DYNA BU 81 - BU 84
4576094	
48435-36050	

BATENTE DA BARRA ESTABILIZADORA	
	HIACE LH50 - LH51
4576098	
48815-26020	∅F-25 A-43 C-47 L-41

BATENTE DE MOLA	
	DYNA
4576102	
	A-100 C-100 L-64

BATENTE DE MOLAS	
	DYNA
4576105	
	A-100 C-106 L-72

BATENTE INFERIOR DA MOLA DA FRENTE	
	HILUX LN50
4576107	
48304-35080	∅P-2x8 A _P -2x30 A-52 C-85.5 L-65

BATENTE DE MOLA	
	HIACE
4576111	
	A-30 C-115 L-67 ∅F-16.5

CASQUILHO DA MOLA POSTERIOR	
	COROLLA
4576007	
90385-13065	∅E-49.5 ∅E _A -58.5 ∅F-13 A-38

CASQUILHO DA MOLA POSTERIOR	
	COROLLA
4576008	
90385-13071	∅E-24.5 ∅E _A -29.5 ∅F-14.5 A-40

CASQUILHO DA BARRA ESTABILIZADORA	
	COROLLA
4576015	
48817-10010	∅E-26.5 ∅F-9 A-21.5



CASQUILHO POSTERIOR DA MOLA	
	HILUX LN65
4576056	
90385-18007	ØE-30 ØEA-34.5 ØF-18 A-57

CASQUILHO DA BARRA ESTABILIZADORA	
	HILUX RN20
4576057	
48817-20020	ØE-26 ØF-9 A-21

APOIO DA CABINE	
	
4576075	
52201-25020	ØE-54.5 ØF-17 A-29

APOIO DA CABINE	
	
4576077	
52202-25020	ØE-50 ØF-18 A-35

CASQUILHO DE MOLAS POSTERIOR OLHAL DE TRÁS	
	DYNA BU 15 DYNA BU 30 DYNA BU 81 DYNA BU 84 DYNA BJ 40
4576089	
90385-23037	ØE-39.5 ØEA-47 ØF-23 A-45.5

CASQUILHO DE MOLAS POSTERIOR E ANTERIOR - OLHAL DA FRENTE	
	DYNA BU 15 - BU 30 - BU 150 DYNA LY 60 - LY 61
4576090	
90385-18025 90385-18005	ØE-30 ØEA-35 ØF-17.5 A-40.5

CASQUILHO DE MOLAS	
	LAND CRUISER BI 40 até 7/80
4576091	
90385-15016 90385-15002	ØE-25 ØEA-31 ØF-15 A-40.5

CASQUILHO DE MOLAS POSTERIOR OLHAL DA FRENTE	
	HIACE LH 51 HILUX LN 85
4576092	
90385-18008	ØE-30 ØEA-35 ØF-18 A-57.5



CASQUILHO DE NYLON PARA EXTERIORES SUPLEMENTO DA PEÇA 4576089	
	DYNA
4576093	
	ØE-43 ØE _A -56.5 ØF-40 A-34

CASQUILHO DE FERRO PARA EXTERIORES SUPLEMENTO DA CASQUILHO 4576089	
	DYNA
4576093.1	
	ØE-43 ØE _A -57.5 ØF-40 A-35

CASQUILHO DA MOLLA POSTERIOR OLHAL DE TRÁS	
	HILUX
4576096	
90385-18046	ØE-30 ØE _A -34 ØF-18 A-37

CASQUILHO DE MOLAS - TRÁS OLHAL DA FRENTE	
	COROLLA 1200 - KE20 - KE25
4576106	
90385-10015	ØE-23.5 ØE _A -29 ØF-10 A-32

CASQUILHO DE MOLAS - TRÁS OLHAL DA FRENTE	
	COROLLA 1200 - KE26
4576108	
90385-10014	ØE-34 ØE _A -39 ØF-10 A-33.5

CASQUILHO DE MOLAS DE TRÁS	
	HILUX LN15
4576110	
90385-18007	ØE-30 ØE _A -35 ØF-18 A-56

CASQUILHO MOLAS	
	HILUX
4576114	
	ØE-30 ØE _A -35.5 ØF-18 A-38

CASQUILHO MOLAS	
	HILUX
4576115	
	ØE-30 ØE _A -35 ØF-17 A-48.5



CASQUILHO AMORTECEDOR	
	
4576118	
	ØE-27 ØEA-30.5 ØF-13 A-25

CAPA DE PEDAL DO TRAVÃO E EMBRAIAGEM	
	HIACE LH20 HILUX RN30
4576059	
31321-14010	C-61 L-58

CAPA DE PEDAL DO TRAVÃO E EMBRAIAGEM	
	HILUX RN20
4576060	
31321-22010	C-48 L-72

CAPA DE PEDAL DO TRAVÃO E EMBRAIAGEM	
	DUNA BU30 - BU81
4576097	
31321-36010	A-12 C-66 L-65

BOTÃO DE AFINAÇÃO DO CAPOT	
	
4576001	
53382-20011	

TAMPA DO ÓLEO	
	COROLLA
4576012	
12181-13010	

FOLE PARA O TRAVÃO	
	COROLLA
4576013	
47230-20010	ØE-62 ØF-8 A-20

FOLE PARA O TRAVÃO	
	COROLLA
4576014	
47230-12011	ØE-73 ØF-8 A-19

VEDANTE DO ÓLEO	
	COROLLA
4576039	
11183-15010	A-14 C-53 L-26.5

ESTICADOR DO TUBO DE ESCAPE	
	HILUX após 79 LITEACE PREVIA RAVV4 4 RUNNER
4576099	
17561-74110	∅F-3x8 A-25.5

ESTICADOR DE ESCAPE	
	CAMY CELICA COROLLA LH102
4576109	
17565-63030 17565-16080 17565-35010	∅F-2x10 A-25 C-65 L-56

FOLE DA CAIXA	
	HILUX RN30
4576061	
58286-89103	

FOLE DA ALAVANCA DE VELOCIDADES	
	HILUX LN40
4576062	
58286-89109	

FOLE DA ALAVANCA DE VELOCIDADES	
	
4576078	
58273-90300	

FOLE JUNTO CAIXA DE VELOCIDADES	
	CORONA 1.8 - 2.0 COROLLA 1.6 após 10/84
4576104	
04438-32011 43448-32020	∅F _G -72 ∅F _P -25 A-96

PALA TOYOTA RODADO SIMPLES	
	
4576095	



PALA TOYOTA RODADO DUPLO	
	
4576103	
	C-450 L-335

SILENT-BLOC DO BRAÇO INFERIOR DA SUSPENSÃO	
	COROLA AE80 - EE80
4576004	
48655-20030	ØF-18 A-50 C-61 L-49.5

SILENT-BLOC DO BRAÇO DE SUSPENSÃO	
	COROLLA
4576005	
48725-32080	ØE-30 ØEA-40 ØF-12.5 A-59

SILENT-BLOC DO BRAÇO SUPERIOR DA SUSPENSÃO	
	HILUX RN30
4576054	
48632-30020	ØE-37 ØEA-49.5 ØF-18 A-47

SILENT-BLOC POSTERIOR DE MOLAS	
	HIACE LH20 - LH50 - LH51 HIACE LH102
4576064	
90389-14007	ØE-40 ØF-14 AE-60 A-70

SILENT-BLOC DO BRAÇO DE SUSPENSÃO	
	CORONA RT60
4576071	
48632-22010	ØE-33 ØEA-41 ØF-15 A-39

SILENT-BLOC DO BRAÇO DE SUSPENSÃO	
	CORONA RT60
4576072	
48654-22010	ØE-33 ØEA-41 ØF-12 A-62

SILENT-BLOC DO BRAÇO DE SUSPENSÃO	
	CORONA RT100
4576073	
48061-20020	ØE-45 ØEA-55.5 ØF-14.5 A-69

SILENT-BLOC DE MOLAS	
	HIACE LH 20 HIACE LH 50 HIACE LH 51 HIACE LH 102
4576087	
90389-14007 90389-14037	∅E-40 ∅F-14 A _E -60 A _I -70

SILENT-BLOC DE MOLAS POSTERIOR E ANTERIOR	
	DYNA BU 15 DYNA BU 30 DYNA BU 80 DYNA WV 96
4576088	
90389-16002 90389-16003	∅E-40 ∅F-16 A _E -70 A _I -75

SILENT-BLOC DO BRAÇO INFERIOR DA SUSPENSÃO	
	HILUX LN56 - LN85 - RN30
4576101	
48654-35010	∅E-40 ∅E _A -51 ∅F-18 A-94

SILENT-BLOC DO BRAÇO INFERIOR DA SUSPENSÃO	
	COROLLA AE 80 - KE 20
4576112	
48654-12010	∅E-30 ∅E _A -41.5 ∅F-12 A-59.5

TUBO SUPERIOR DO RADIADOR	
	COROLLA STARLET
4576079	
90916-01169	

TUBO INFERIOR DO RADIADOR	
	COROLLA STARLET
4576080	
16571-13090	

TUBO SUPERIOR DO RADIADOR	
	HIACE HILUX
4576082	
16572-54030	

TUBO SUPERIOR DO RADIADOR	
	HIACE HILUX
4576083	
16572-54050	



TUBO INFERIOR DO RADIADOR	
	HIACE HILUX
4576086	
16572-54030	



SUPORTE ANTERIOR DO MOTOR	
	GOLF II 1.1 - 1.3 - 1.6 - 1.8 - GTI GOLF II D - TD JETTA II 1.1 - 1.3 - 1.6 - 1.8 JETTA II GTI JETTA II D - TD PASSAT TD após 4/88
4560002	
191199279B 191199279C	ØFR-8 ØFR-10 ØP-10 AP-23

SUPORTE POSTERIOR DIREITO DO MOTOR	
	CORRADO GOLF II JETTA II PASSAT após 4/88
4560005	
191199262A	ØF-11.5 A-123.5 C-109 L-75.5

SUPORTE POSTERIOR ESQUERDO DO MOTOR	
	CORRADO GOLF II JETTA II PASSAT
4560006	
191199402 191199402A 191199402B 191199402B	ØFR-10 ØF-2x10 A-82.5 C-137 L-82

SUPORTE ANTERIOR DO MOTOR	
	PASSAT até 3/88
4560010	
823199381B 893199381B	ØP-10 AP-23 ØP-10 AP-21 A-59 C-63.5 L-87

SUPORTE POSTERIOR DO MOTOR	
	GOLF I D JETTA I D
4560018	
171399151B	ØP-12\2x8 AP-16\2x15 A-43 C-89 L-66

SUPORTE SUPERIOR DO AMORTECEDOR ANTERIOR	
	CORRADO GOLF II GOLF III JETTA II VENTO
4560022	
1764122329A 191412331 191412329	ØE-129 ØF-14 A-52

SUPORTE ANTERIOR DO MOTOR HIDRÁULICO	
	GOLF II 1.1 - 1.3 - 1.6 - 1.8 - GTI GOLF II D - TD JETTA II 1.1 - 1.3 - 1.6 - 1.8 JETTA II GTI JETTA II D - TD PASSAT TD após 4/88
4560025	
191199279B 191199279C	ØFR-8 ØFR-10 ØP-10 AP-23

SUPORTE POSTERIOR DIREITO DO MOTOR COM CARÇAÇA	
	GOLF III D GOLF III TD VENTO D VENTO TD
4560026	
1H0199262B	A-130 C-154 L-107



SUPORTE ANTERIOR DO MOTOR SEM CARÇAÇA	
	GOLF III D GOLF III TD PASSAT 2.0 VENTO D VENTO TD
4560027	
1H0199609B	ØFr-2x10 A-133 C-107

APOIO SUPERIOR DO AMORTECEDOR ANTERIOR - COM ROLAMENTO	
	DERBY POLO
4560033	
871412323A	ØE-76 ØF-20.5 ØF-12 A-42

SUPORTE POSTERIOR DIREITO DO MOTOR	
	GOLF II 1.8 GTI 16V JETTA II 1.8 16V PASSAT após 4/88
4560039	
535199262 191199262C	ØFr-2x10 ØFr-3x8 A-130 L-101

APOIO SUPERIOR DO AMORTECEDOR ANTERIOR - COM ROLAMENTO	
	PASSAT até 3/88
4560043	
811412323C	ØE-76 ØF-14 ØF-21 A-42

APOIO SUPERIOR DO AMORTECEDOR ANTERIOR	
	GOLF III 2.0 - 2.8 PASSAT após 4/88 VENTO 2.0 - 2.8
4560073	
357412331A	ØE-89 ØF-28 A-50 ØE-92 ØF-14 A-30.5

SUPORTE POSTERIOR DO MOTOR LADO DA CAIXA DE VELOCIDADES	
	GOLF II 1.1 - 1.3 GOLF III 1.4 - 1.6 JETTA II 1.1 - 1.3 VENTO 1.4 - 1.6
4560078	
191199381A	ØF-2x10 ØFr-10 A-66.5 C-137 L-82.5

APOIO SUPERIOR DA SUSPENSÃO ANTERIOR	
	GOLF I JETTA I SCIROCCO
4560084	
171412329A 175412329A	ØF-14.5 ØP-2x8 Ap-2x17.5 A-50 C-170 L-134

FOLE CENTRAL DO AMORTECEDOR ANTERIOR	
	PASSAT após 4/88
4525023	
357412303F	ØF-18 ØE-50 A-83



BATENTE CENTRAL DA BARRA ESTABILIZADORA	
	PASSAT
4560009	
	∅F-20 A-47.5 C-34 L-41

BATENTE SUPERIOR DO AMORTECEDOR ANTERIOR	
	GOLF II GOLF III JETTA II PASSAT após 4/88 VENTO
4560028	
191412303 191412303A 357412303E 1H0412303A	∅E-59.5 A-84

BATENTE CENTRAL DO AMORTECEDOR POSTERIOR - COM RESGUARDO	
	GOLF II GOLF III JETTA II VENTO
4560029	
191512131 191512131B	∅E-56 ∅F-14 ∅F-11 A-150

BATENTE LATERAL DA BARRA ESTABILIZADORA ANTERIOR	
	PASSAT até 3/88
4560032	
823411313A	∅F-12.5 A-43.5 C-40.5 L-24.5

BATENTE DA BARRA ESTABILIZADORA ANTERIOR	
	GOLF II GOLF III JETTA II VENTO
4560036	
191411314	∅F-16 A-36 C-34 L-32.5

BATENTE CENTRAL DO AMORTECEDOR ANTERIOR	
	DERBY 1.3 PASSAT até 3/88 POLO 1.3
4575007	
811412131B 893412131B	∅E-52 A-65

APOIO DA EXTREMIDADE DA TRAVESSA ANTERIOR	
	GOLF II GOLF III JETTA II PASSAT após 4/88 VENTO
4560047	
191199233	∅E-51 ∅F-16 A-40

SUPORTE DO TUBO DE ESCAPE	
	GOLF III 1.4 - 1.6 VENTO 1.4 - 1.6
4560075	
823253149A	∅E-29.5 ∅F-14 A-14



CAPA DE PEDAL DO TRAVÃO E EMBRAIAGEM	
	GOLF II JETTA II PASSAT POLO TRANSPORTER desde 91
4560014	
321721173	A-10 C-66 L-55

CAPA DE PEDAL DO TRAVÃO E EMBRAIAGEM	
	DERBY GOLF I JETTA I PASSAT até 7/80 POLO até 90 SCIROCCO
4560015	
823721173	A-9.5 C-60 L-50.5

ESTICADOR DA BARRA ESTABILIZADORA	
	GOLF II JETTA II POLO
4560012	
191411315	ØF-15.5 ØP-10 Ap-45 A-40 C-94

KIT DE REPARAÇÃO DA ALAVANCA DA CAIXA DE VELOCIDADES	
	GOLF JETTA
	4xCASQUILHO PLÁSTICO ØE-12 ØEA-16 ØF-8 A-10 1xABRAÇADEIRA A-12 C-51.5 L-21 1xABRAÇADEIRA A-10 C-51.5 L-30 1xMEIA LUA PLÁSTICA A-13.5 C-21.5 L-15
4560013	
Ref. Original	
Ref. Original	

BATENTE DO TUBO DE ESCAPE	
	GOLF II JETTA II POLO D desde 91
4560023	
431253149A	ØE-20 ØF-5 A-35

TAMPÃO SUPERIOR DO AMORTECEDOR ANTERIOR	
	DERBY PASSAT de 74 a 79 POLO
4560041	
861412131	ØE-43 ØF-18.5 A-45

ANEL DE ESCAPE	
	DERBY GOLF I JETTA I POLO
4545023	
861253147	ØE-63 A-15

SUPORTE DO TUBO DE ESCAPE	
	CADDY após 82 DERBY após 77 GOLF após 74 JETTA após 79 PASSAT de 73 a 89 POLO após 75 SANTANA de 81 a 86 SCIROCCO de 74 a 88 A-12 C-60 L-57.5
4560001	



ANEL DE ESCAPE	
	GOLF I 1300 GOLF I 1600 GOLF I D JETTA I C JETTA I CL JETTA I GLE JETTA I 1600D
4560004	
191253147A	ØE-56.5 ØF-30 A-13.5 C-64.5

SUPORTE DO TUBO DE ESCAPE	
	PASSAT após 4/88
4560011	
357253144C 357253144D 357253144E	ØF-12.5 A-62.5 C-126 L-34.5

SUPORTE DO TUBO DE ESCAPE	
	GOLF SCIROCCO
4560016	
533253147	A-38 C-69 L-48

SUPORTE DO TUBO DE ESCAPE VIATURAS COM CATALIZADOR	
	GOLF III 2.0 GOLF III D - TD VENTO 2.0 VENTO D - TD
4560076	
1H0253147B	ØF-2x12 A-34 C-70 L-50

SUPORTE CENTRAL DO TUBO DE ESCAPE	
	GOLF III 1.4 - 1.6 - 1.8 GOLF III D - TD VENTO 1.4 - 1.6 - 1.8 VENTO D - TD
4560083	
1H253144 1H253144A 1H253144C	A-67 C-120.5 L-34

SUPORTE DO TUBO DE ESCAPE	
	GOLF I JETTA I PASSAT até 3/88 SCIROCCO TRANSPORTER
4575008	
803253147 171253147	A-13 C-63 L-52

RESGUARDO DO AMORTECEDOR ANTERIOR	
	PASSAT até 3/88
4560030	
811412135B	ØFg-75 ØFp-50 A-98.5

FOLE DIREITO DO SEMI-EIXO DIFERENCIAL LADO DA CAIXA DE VELOCIDADES	
	GOLF II 1.8 - 1.8 GTI 16V GOLF III 1.8 - 2.0 JETTA II 1.8 - 1.8 GTI 16V PASSAT após 4/88 VENTO 1.8 - 2.0
4560035	
191407283 191498202	ØFg-100 ØFp-36 A-120



FOLE DO SEMI-EIXO DIFERENCIAL LADO DA RODA	
	DERBY de 83 a 84 POLO de 83 a 84 GOLF II 1.8 JETTA II 1.8 PASSAT 2.0 até 3/88 PASSAT 2.2 até 3/88 SCIROCCO 1.8 de 84 a 92
4560045	
811498203 431407285B	ØF _G -83 ØF _P -22 A-84

FOLE ESQUERDO E DIREITO DA DIRECÇÃO VIATURAS COM DIRECÇÃO ASSISTIDA ZF	
	GOLF III PASSAT após 4/88 VENTO
4560046	
357422831B	ØF _G -46 ØF _P -13 A-138

FOLE ESQUERDO E DIREITO DA DIRECÇÃO ASSISTIDA	
	GOLF II GOLF III JETTA II VENTO SCIROCCO
4560048	
175422831 191422831 1H0422831	ØF _G -42 ØF _P -10 A-210

FOLE ESQUERDO E DIREITO DA DIRACÇÃO	
	DERBY até 9/79 POLO
4560053	
861419831B	ØF _G -34 ØF _P -21 A-110

FOLE DA CAIXA DA DIRECÇÃO	
	DERBY POLO
4560054	
861419832	ØF-34 A-129

FOLE DO SEMI-EIXO DIFERENCIAL LADO DA CAIXA DE VELOCIDADES	
	TRANSPORTER
4560055	
211501149 211598201	ØF _G -100 ØF _P -21 A-100

FOLE DO SEMI-EIXO DIFERENCIAL LADO DA CAIXA DE VELOCIDADES	
	GOLF VENTO
4560056	
	ØF _G -100 ØF _P -21 A-110

FOLE DO SEMI-EIXO DIFERENCIAL LADO DA RODA	
	DERBY GOLF I GOLF II JETTA I JETTA II PASSAT até 80 POLO 0.9-1.1-1.3 de 11/83 a 90 SCIROCCO
4560057	
321407285B	ØF _G -75 ØF _P -20 A-83



FOLE EM NYLON DO AMORTECEDOR ANTERIOR	
	PASSAT até 3/88
4560060	
811412135B	ØF _G -73 ØF _P -44 A-95

FOLE ESQUERDO E DIREITO DA DIRECÇÃO	
	GOLF II após 87 GOLF III sem direcção assistida JETTA II após 87 PASSAT após 4/88 sem d.a. VENTO sem direcção assistida
4560061	
191419831	ØF _G -40.5 ØF _P -25 A-120

FOLE DO SEMI-EIXO DIFERENCIAL LADO DA CAIXA DE VELOCIDADES	
	GOLF I 1.5 - 1.6 GOLF II GOLF III D - TD JETTA I 1.5 - 1.6 JETTA II MAGGIOLINO após 6/69
4560062	
113501149	ØF _G -94 ØF _P -20 A-78.5

FOLE DO SEMI-EIXO DIFERENCIAL LADO DA CAIXA DE VELOCIDADES	
	PASSAT até 3/88 PASSAT 1.6 após 4/88 PASSAT 1.6 TD após 4/88 SCIROCCO 1.8 VENTO D - TD
4560062	
113501149	ØF _G -94 ØF _P -20 A-78.5

FOLE EM NYLON DO AMORTECEDOR ANTERIOR	
	GOLF II GOLF III JETTA II PASSAT após 4/88 SCIROCCO VENTO
4560063	
191412135 357412135	ØF _G -70 ØF _P -53 A-94

FOLE DO SEMI-EIXO DIFERENCIAL LADO DA RODA	
	GOLF I GOLF II GOLF III 1.4 - 1.6 - 1.9 - D - TD JETTA I JETTA II PASSAT de 81 a 3/88 PASSAT 1.6-1.8-1.6 TD após 4/88
4560067	
191498203C	ØF _G -77 ØF _P -25 A-107

FOLE DO SEMI-EIXO DIFERENCIAL LADO DA RODA	
	POLO após 91 - só fole esquerdo SCIROCCO de 80 a 84 VENTO 1.4 - 1.6 - 1.9 - D - TD
4560067	
191498203C	ØF _G -77 ØF _P -25 A-107

FOLE DO AMORTECEDOR ANTERIOR	
	GOLF III VENTO
4560082	
357413175	ØF _G -59 ØF _P -57 A-165



JOGO DE PALAS VOLKSWAGEN	
	GOLF
4560085	
	A-415 L-190

SILENT-BLOC POSTERIOR DO BRAÇO DE SUSPENSÃO ANTERIOR	
	GOLF II GOLF III JETTA II PASSAT após 4/88 VENTO
4560003	
191407181D 191407181E	ØE-60 ØF-17 A _E -24 A _I -41

SILENT-BLOC ANTERIOR DO BRAÇO DE SUSPENSÃO ANTERIOR	
	GOLF I JETTA I SCIROCCO
4560007	
171407182D 171407182E	ØE-32 ØE _A -35 ØF-12 A-61

SILENT-BLOC POSTERIOR DO BRAÇO DE SUSPENSÃO ANTERIOR	
	GOLF I JETTA I SCIROCCO
4560008	
171407181A	ØE-51 ØF-18 ØF-6 A-49.5 C-58

SILENT-BLOC ANTERIOR DO BRAÇO DE SUSPENSÃO ANTERIOR	
	GOLF II JETTA II PASSAT após 4/88
4560017	
191407182 357407182	ØE-32.5 ØE _A -36 ØF-12 A-54

SILENT-BLOC DA SUSPENSÃO	
	TRANSPORTER
4560024	
251407077	ØE-36 ØE _A -59 ØF-18.5 A-52

SILENT-BLOC POSTERIOR DO BRAÇO DE SUSPENSÃO ANTERIOR	
	GOLF II GOLF III JETTA II PASSAT após 4/88 VENTO
4560031	
191407181A 191407181B	ØE-60 ØE _A -67.5 ØF-17 A-41.5

SILENT-BLOC ANTERIOR DO BRAÇO DE SUSPENSÃO ANTERIOR	
	GOLF II JETTA II PASSAT após 4/88
4560040	
191407182 357407182	ØE-33 ØE _A -35.5 ØF-12 A-54



SUPORTE DA SUSPENSÃO POSTERIOR	
	GOLF II JETTA II
4560044	
191501541	∅E-44.5 ∅F-12 A-90

SILENT-BLOC DA TRAVESSA DA SUSPENSÃO POSTERIOR	
	PASSAT após 4/88
4560074	
333501541 357501541 357501541A	∅E-56.5 ∅F _G -17.5 ∅F _P -12 A-50

SILENT-BLOC DO BRAÇO SUSPENSÃO ANTERIOR VIATURAS COM DIRECÇÃO ASSISTIDA	
	PASSAT até 3/88
4575001	
857407181	∅E-37 ∅E _A -48 ∅F-10 A-44

TUBO DE LIGAÇÃO DA BOMBA AO TERMOSTATO	
	GOLF III 1.4 POLO 1.0 POLO 1.3 VENTO 1.4
4525022	
030121063C	∅F _G -30 ∅F _P -28.5

TUBO DE LIGAÇÃO DA BOMBA DE ÁGUA AO TERMOSTATO	
	GOLF I D GOLF II D - TD JETTA I D JETTA II D - TD PASSAT de 8/77 a 3/88
4560034	
068121053A 068121053E 068121053Q	∅F-24 ∅F-24

TUBO SUPERIOR DE ENTRADA DE ÁGUA DO RADIADOR	
	DERBY POLO 1.0 de 8/85 a 90 POLO 1.3 de 8/85 a 90
4560042	
030121055B	∅F-30 ∅F-30

TUBO DE LIGAÇÃO DA BOMBA DE ÁGUA AO TERMOSTATO	
	GOLF II 1.6 - 1.8 JETTA II 1.6 - 1.8 PASSAT 1.6 - 1.8
4560049	
026121053A 026121053F 026121053G	∅F-24 ∅F-24

TUBO INFERIOR DE SAÍDA DA ÁGUA DO RADIADOR	
	GOLF I 1.1 - 1.3 JETTA I 1.1 - 1.3 SCIROCCO 1.1 - 1.3
4560050	
171121051C 171121051E 171121051J 171121051L	∅F-30 ∅F-30

TUBO DE LIGAÇÃO DO RADIADOR AO COLECTOR	
	GOLF I 1.3 JETTA I 1.3
4560051	
052121056E	ØF _G -18.5 ØF _P -14

TUBO DE LIGAÇÃO DE SAÍDA DE ÁGUA DO RADIADOR PARA O TERMOSTATO	
	GOLF I 1.1 - 1.3 após 8/82 GOLF II 1.3 JETTA I 1.1 - 1.3 após 8/82 JETTA II 1.3 POLO de 10/81 a 90 SCIROCCO 1.1 - 1.3 após 8/82
4560052	
052121054B 052121054D	ØF _G -18 ØF _P -14

TUBO INFERIOR DE SAÍDA DE ÁGUA DO RADIADOR	
	GOLF II 1.6 - 1.8 com ar condicionado GOLF II TD JETTA II 1.6 - 1.8 com ar condicionado JETTA II TD
4560059	
191121051G 191121051P	ØF _G -32 ØF _P -30

TUBO SUPERIOR DE ENTRADA DE ÁGUA DO RADIADOR	
	GOLF II 1.8 GOLF II D JETTA II 1.8 GTI JETTA II D
4560064	
191121101F 191121101S	ØF-30 ØF-30

TUBO DE LIGAÇÃO DA SAÍDA DE ÁGUA DO RADIADOR AO TERMOSTATO	
	GOLF I 1.1 - 1.3 GOLF II 1.3 JETTA I 1.1 - 1.3 JETTA II 1.3 POLO de 10/81 a 90 SCIROCCO 1.1 - 1.3 após 8/82
4560065	
052121054B 052121054D	ØF _G -17 ØF _P -15

TUBO DE TRÊS VIAS DE LIGAÇÃO DO AQUECIMENTO AO RADIADOR	
	GOLF II TD JETTA II TD
4560066	
068121053AB 068121053P	ØF _G -24 ØF _P -14.5

TUBO DE TRÊS VIAS DE LIGAÇÃO DA BOMBA DE ÁGUA AO TERMOSTATO	
	PASSAT 1.6 TD
4560066	
068121053AB 068121053P	ØF _G -24 ØF _P -14.5

TUBO DE LIGAÇÃO DA BOMBA DE ÁGUA AO TERMOSTATO	
	GOLF I D GOLF II D - TD JETTA I D JETTA II D - TD PASSAT D de 8/77 a 3/88
4560068	
068121053A 068121053E 068121053Q	ØF-25 ØF-25



TUBO SUPERIOR DE ENTRADA DE ÁGUA DO RADIADOR - VIATURAS COM AR CONDICIONADO	
	GOLF II 1.6 - 1.8 GOLF II TD JETTA II 1.6 - 1.8 JETTA II TD
4560069	
191121101B 191121101Q	ØF-30 ØF-30

TUBO DE TRÊS VIAS DE LIGAÇÃO DO AQUECIMENTO AO RADIADOR	
	GOLF II D - TD JETTA II D - TD
4560070	
037121058 068121058D	ØF-24 ØF-19 ØF-15

TUBO DO AQUECIMENTO DE LIGAÇÃO AO TERMOSTATO	
	GOLF II TD JETTA II TD
4560071	
171121611B	ØF-25 ØF-15.5

TUBO INFERIOR DE SAÍDA DE ÁGUA DO RADIADOR	
	GOLF II 1.8 GTI GOLF II D JETTA II 1.8 GTI JETTA II D
4560072	
191121051F	ØF-31 ØF-31

TUBO DE LIGAÇÃO DO RADIADOR AO COLECTOR	
	GOLF II 1.3 JETTA II 1.3
4560077	
052121056E	ØF _G -19 ØF _P -14.5

TUBO DE LIGAÇÃO AO TERMOSTATO	
	GOLF I GTI GOLF II JETTA I GLI - D JETTA II D SCIROCCO 1.5 - 1.6
4560079	
171121611AN 171121611E 171121611F	ØF-24 ØF-15

TUBO DE TRÊS VIAS DE LIGAÇÃO DA BOMBA DE ÁGUA AO TERMOSTATO	
	GOLF II TD JETTA II TD
4560080	
068121053AG	ØF-24.5 ØF-24.5 ØF-15

TUBO DE TRÊS VIAS DE LIGAÇÃO DA BOMBA DE ÁGUA À CABEÇA DO CILINDRO	
	PASSAT D de 86 a 3/88 PASSAT TD de 86 a 3/88
4560080	
068121053AG	ØF-24.5 ØF-24.5 ØF-15



TUBO SUPERIOR DE ENTRADA DE ÁGUA DO RADIADOR	
	GOLF I 1.5 - 1.6 até 12/80 SCIROCCO 1.5 - 1.6 até 12/80
4560081	
171121101B	ØF-33 ØF-30

TUBO DE LIGAÇÃO DA BOMBA DE ÁGUA AO TERMOSTATO	
	GOLF/JETTA I D GOLF/JETTA II D - TD PASSAT D de 8/77 a 3/88
4575002	
068121053A/E 068121053M/Q	ØF-24

TUBO DE LIGAÇÃO DA BOMBA DE ÁGUA AO TERMOSTATO	
	GOLF/JETTA II 1.6 GOLF/JETTA II 1.8
4575005	
026121053A 026121053G 026121053F	ØF-33



SUPORTE DA CAIXA DE VELOCIDADES	
	VOLVO
4450060	
522.934	ØE-56 ØF-18 ØF-2x10 A-70

SUPORTE DO TRAVÃO ELÉCTRICO	
	VOLVO
4450061	
	ØE-55.5 ØF-18 ØF-3x8 A-70

SUPORTE DE MOLAS	
	VOLVO F7 - FL7 - F10 - F12 VOLVO FH12 - F16 - FH16 VOLVO N10 - N12 - NL10 - NL12
4450065	
1629553	A-150 C-210 L-150

APOIO DO EIXO	
	VOLVO CAMIÃO EIXO FIXO
4450088	

BATENTE DA BARRA ESTABILIZADORA	
	SCANIA VOLVO
4450062	
767.334	ØF-46 A-76 C-79 L-60

BATENTE DA BARRA ESTABILIZADORA EM NYLON	
	VOLVO F 12 - F 10 - N10 - F 16 N12 - F7 - NL 10 - F 57 FL 616 - FL 619
4450077	
1611551-1	ØF-40 A-61 C-64 L-51

SEPARADOR DE MOLAS	
	VOLVO F 7 - F 16 - FE 6 - FE 7 FL 7 - FL 10
4450078	
1591299	ØF-2x17 ØF-2x10 A-11 C-98 L-88

SEPARADOR DE MOLAS PEQUENO	
	VOLVO FS 7 - FL 616 - FL 619 FL 608 - FL 614 - FL 4 FE 7 - FE 6 - F 6
4450079	
6775502-5	ØF-2x17,5 ØF-2x8 A-12 C-80 L-70



SEPARADOR DE MOLAS	
	VOLVO FH 12 - 16
4450109	
Ref. Original	ØF-2x8
Ref. Original	A-10.5 C-139 L-84

BATENTE DE ESTABILIZADOR	
	VOLVO N10 - F10
4450110	
	ØF-45
	A-75 C-106 L-80

BATENTE DE ESTABILIZADOR	
	VOLVO F7 - F10 - F12
4450111	
15730328	ØF-50
	A-74 C-106 L-80

BATENTE DA BARRA ESTABILIZADORA	
	VOLVO FL7 - F16 - N7 - F7 VOLVO N10 - N12
4450113	
1575339-5	ØF-50
	A-91.5 C-98 L-103

BATENTE DA BARRA ESTABILIZADORA SEM ABA	
	VOLVO FL10 - FL7 - F16 - N7 VOLVO F7 - N10 - N12
4450113.1	
	ØF-50
	A-93 C-98 L-103.5

CASQUILHO DE AMORTECEDORES	
	VOLVO FL 10 - FL 7 - FS 8 - FL 4 FE 7 - FE 6 - F16 - F6 B7F - F10 - F12 - H10 H12
4450072	
1134962-B	ØE-47 ØF-25
	A-26

CASQUILHO DE NYLON	
	VOLVO FL 616 - FL 619 - FL 608 FL 614 - FL 7 - FL 10 F 57 - F 7 - F 16 - F 10 F 12 - N 10 - N 12 NL 10 - NL12
4450074	
1589807	ØE-34.5 ØE _A -45 ØF-25
	A-23

CASQUILHO DE NYLON	
	VOLVO F12 NL 105 - FL 6 FL 6 NL 125 - FL 7 FL 10
4450075	
1587261	ØE-35 ØE _A -45 ØF-25
	A-26



SUPORTE DO TUBO DE ESCAPE	
	740 após 86 760 após 87
4525005	
	A-27.5 C-54 L-44

FOLE DO SEMI-EIXO DIFERENCIAL LADO DA CAIXA DE VELOCIDADES - COM ROLAMENTO DE 25.8mm	
	460 480
4530142	
3447721.6	∅F _G -85 ∅F _P -25.8 A-80

PALAS DE CAMIÃO	
	VOLVO
4450090	
	C-600 L-340

CAVILHA - SILENT-BLOC DE MOLAS	
	VOLVO
4450006	
343.348-9	∅E-51 C-168 C _T -89

CAVILHA - SILENT-BLOC DE MOLAS	
	VOLVO
4450007	
6.850.876.1	∅E-45.5 C-160 C _T -100

CAVILHA - SILENT-BLOC DE MOLAS	
	VOLVO
4450008	
6.850.874.6	∅E-41 C-130 C _T -70

SILENT-BLOC DE MOLAS	
	VOLVO FL 7
4450009	
6.879.332.2	∅E-50 ∅E _A -55 ∅F-16 A-95

CASQUILHO	
	VOLVO N10 - B10M - B58
4450064	
1.135.045.1	∅E-56 ∅E _A -62 ∅F-20 A-120.5



SILENT-BLOC DE MOLAS	
	VOLVO
4450087	
	ØE-55 ØF-26 A _E -101 A _F -112



SUORTE DO TRAVÃO ELECTRICICO	
	
4450104	
522.934	ØE-56 ØF-18 A-70

SUORTE DA CAIXA DE VELOCIDADES	
	
4450060	
522.934	ØE-56 ØF-18 ØF-2x10 A-70

SUORTE DO TRAVÃO ELÉCTRICO	
	
4450061	
	ØE-55.5 ØF-18 ØF-3x8 A-70

APOIO DE FAROLINS DE PESADOS	
	
4450118	
	ØP-8 A-18 A-30 C-95 L-31

APOIO DAS BÁSCULAS EM ALUMÍNIO	
	
4450124	
	A-16 C-169 L-120

BATENTE DE CAIS	
	
4450020	
	A-90 C-240 L-79

BATENTE DE CAIS	
	
4450021	
	A-78 C-210 L-87

BATENTE DE CAIS	
	
4450022	
	A-47 C-193 L-50



BATENTE DE CAIS	
	
4450101	
	A-87 C-119 L-74

BATENTE DE CAIS	
	
4450102	
	A-80 C-195 L-80

BATENTE DE CAIS	
	
4450103	
	A-104 C-345 L-99

BATENTE DA BASCULA	
	
4540105	
	A-20 C-231 L-93

CASQUILHO	
	GALERA
4450003	
210-06540	ØE-101 ØF-60 A-62

CASQUILHO	
	GALERA
4450005	
210-06531-A	ØE-56 ØF-25 A-67

CASQUILHO	
	TRAILER
4450014	
	ØE-61 ØF-32 A-56

CASQUILHO	
	TRAILER
4450015	
	ØE-84 ØF-4x19 A-110.5



CASQUILHO	
	YORK
4450028	
504991	ØE-60 ØF-22 ØF-23.5 A-58

CASQUILHO	
	YORK
4450050	
50-1350	ØE-60 ØF-22.5 A-58

CASQUILHO	
	GALERA
4450051	

CASQUILHO CÔNICO DE MOLAS	
	TRAYLER LECILEÑA
4450117	
	ØE-65 ØF-24 A-81

DISCO EM NYLON PARA MOLAS	
	
4450114	
	ØE-71 A-9

PALAS DE CAMIÃO	
	
4450097	
	C-600 L-340

PALAS DE CAMIÃO RODADO SIMPLES	
	
4450098	
	C-310 L-263

PALAS DE CAMIÃO RODADO DUPLO	
	
4450099	
	C-335 L-450



PALAS DE FURGÃO UNIVERSAL	
	
4450100	
	C-350 L-255

SILENT-BLOC DE MOLAS	
	GALERA
4450001	
210-11745	ØE-48 ØF-22.5 A-76

CASQUILHO	
	GALERA
4450002	
210-11746	ØE-78.5 ØF-52 A-104

CASQUILHO DE MOLAS	
	GALERA ROR BPW
4450049	

SILENT-BLOC	
	GALERA
4450120	
	ØE-49 ØF-23 A-79